

A Novel Multimedia System for Archaeology

John Cosmas, Take Itegaki, Damian Green, Edward Grabczewski, Fred Weimer,

Brunel University, Uxbridge, Middlesex UB8 3PH, United Kingdom, Email: john.cosmas@brunel.ac.uk

Luc Van Gool, Eidgenossische Technische Hochschule Zurich / Katholieke Universiteit Leuven

Alexy Zalesny Eidgenossische Technische Hochschule Zurich

Desi Vanrintel, Eyetrionics NV

Franz Leberl, Markus Grabner, Konrad Schindler, Konrad Karner, Graz University of Technology

Michael Gervautz, Stefan Hynst, Imagination Computer Services GesmbH

Marc Waelkens, Marc Pollefeys, Roland DeGeest, Katholieke Universiteit Leuven

Robert Sablatnig, Martin Kampel, Vienna University of Technology

Abstract

The EU funded project, 3D Measurement and Virtual Reconstruction of Ancient Lost Worlds of Europe (3D MURALE), is creating a set of low-cost multimedia tools for recording, reconstructing, encoding, visualising buildings, building parts, statues, statue parts, pottery, stratigraphy, terrain geometry/texture and material texture with a database for proper storage and retrieval. This paper describes the overall concept of this multimedia system for archaeology and then briefly describes the functionality of the tools provided by the project.

1. Introduction

The archaeological community is realising that new ways of recording, cataloguing, conserving, restoring and presenting archaeological artefacts, monuments and sites can be achieved using multimedia technologies. However many archaeological groups have not widely introduced this technology because of the prohibitive cost, complexity and portability of quality multimedia tools.

The objective of the 3D MURALE project is to develop low-cost, user-friendly and portable 3-D recording tools to register:

- Stratigraphical evidence *in situ*, as archaeological fieldwork by its nature destroys this kind of information;
- Artefacts, mainly for cataloguing and visual or real completion
- Sculptures and buildings, mainly for restoration and visualisation

The 3-D recording techniques should replace present techniques of 2-D recording which only offer a piecemeal representation and are both time consuming and labour intensive.

The final goal is to model the terrain of the site in 3-D as such topographic data yield important information for the archaeologists and is vital for a realistic visualisation. This is all the more important as the ancients designed their cities in harmony with their surroundings, adapting the city layout to the physical geography.

A multimedia database is being created in order to store and retrieve the stratigraphy, artefacts, sculptures and buildings and settlement layout. The database serves several purposes, namely:

- It contains information on all the layers of stratigraphy within the archaeological site that was excavated and on all the artefacts, sculptures and building blocks that was found in each layer. This will allow the user to set a time slider showing the chronology of the whole archaeological process.
- It contains information where all the pieces belong in the scene reconstruction and in which period they were relevant. This will allow the user to set a time slider, after which a complete site model will be composed automatically, showing the buildings, the vegetation, and the artefacts typical for that period.
- It serves as a repository that can be used by the archaeologists to help them classify finds, to prepare restorations, and to keep track of statistics.
- It is a major gateway to the wider public and to other archaeologists, by making much of this information available over the Internet.

Techniques are being developed to use excavated 3-D models of objects or their parts with multimedia tools to allow a virtual and possibly subsequently also physical completion or anastylosis of respectively single artefacts or buildings. These techniques must permit a virtual reconstruction of all excavation phases and their stratigraphy.

Finally, an integrated model will be built of the landscape,

the buildings, and the artefacts and this for different eras, showing reconstructions for these periods or the current state.

Multimedia techniques are being developed to swiftly visualise the site so that people can virtually navigate through. This will call for special measures, such as level-of-detail selection, predicting the next views, exploiting our reduced visual resolution when moving, etc. The visual experience will also include replays of the excavations, showing the different layers of the excavations being 'peeled off' one by one. This will help future archaeologists revisit the site in virtual reality in order to make their own interpretation of the finds.

This paper presents the novel multimedia system and tools for archaeology that is being developed in the 3D MURALE project and the archaeological test site on which these tools are being tested.

2. The Archaeological Test Study Site

The archaeological site at Sagalassos is one of the largest archaeological projects in the Mediterranean dealing with a Greco-Roman site over a period of more than a thousand years (4th century BC-7th century AD). One of the three greatest cities of ancient Pisidia, Sagalassos lies 7 km north of the village Ağlasun in the province of Burdur, Turkey. The ruins of the city lie on the southern flank of the Ağlasun mountain ridge (a part of the Taurus-mountains) at a height between 1400 and 1650 metres. A team from the Katholieke Universiteit Leuven under the direction of Professor Marc Waelkens have been excavating since 1990 and has dug up some wonderful finds. The European Union supported 3D MURALE project is developing 3D measurement, reconstruction and visualisation tools for testing by Prof. Waelken's archaeological team.

3. Multimedia System Architecture

The 3D-Murale system [1] consists of the Recording, Reconstruction, Database and Visualisation components, as shown in fig 1. Recording tools are being developed for measuring terrain, stratigraphy, buildings, building blocks, pottery, pottery sherds and statues on the archaeological site. The results of these measurements were being stored in the 3D-Murale database system. Reconstruction systems are using a 3D graphics tool to combine the individual measured components and reconstruct building elements and buildings from building blocks, pottery from pottery sherds, statues from statue elements and stratigraphy from all finds within the excavation.

Any missing elements are added later through archaeological hypothesis using 3D graphics tools and custom-built software. An integrated model is being built of the landscape, buildings, and artefacts for different eras, showing reconstruction of these periods or the current state.

The model is being processed to prepare it for high quality stereoscopic visualisation and for lower quality Internet visualisation. The visual experience also includes the display of the stratigraphy. Any individual artefact (building element, building, pottery sherd, complete pottery, stones or statues) may be queried on the database and the outcome of the query visualised individually. Queries may be formed and remotely visualised over the Internet.

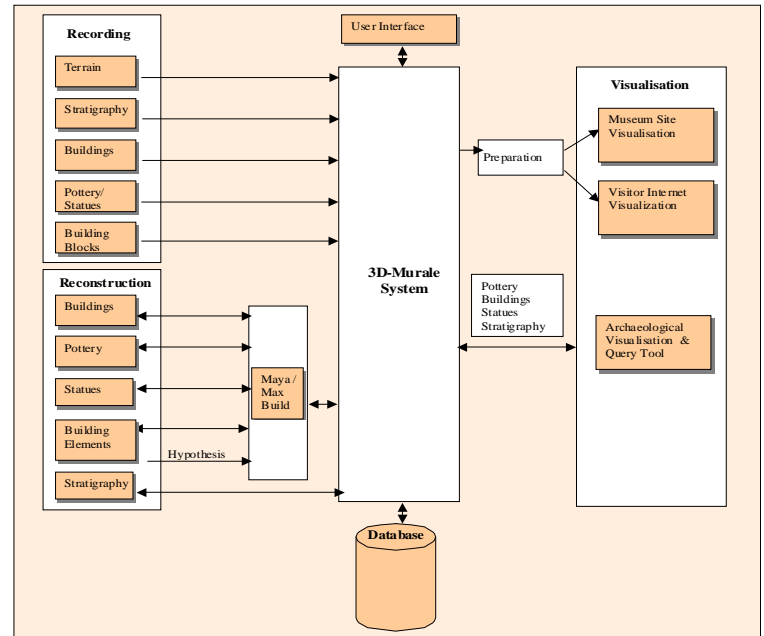

Fig 1: Archaeological Process Flow

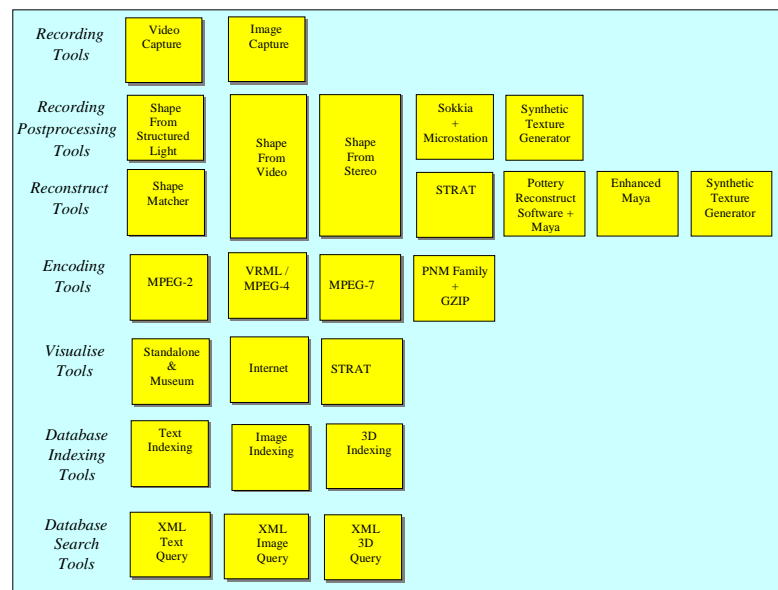

Fig 2: Set of tools

The archaeological multimedia system architecture is based on a set of tools loosely associated with each other through a common database structure. The set of tools, shown in fig 2, can be categorised into recording, recording post-processing, reconstruction, encoding, visualisation and database. It consists of a combination of professionally available multimedia tools that in some cases have been enhanced by software developed within the 3D MURALE project where necessary and tools developed entirely within the 3D MURALE project.

4. Description of 3D MURALE Tool Set

4.1 Recording Tools

The choice of the recording tool that was applied to an artefact is given in table 1. The type of recording tool used is dependant on a number of factors, namely:

- Accuracy: Shape from Video or Stereo were used on artefacts that do not require to be recorded to a high degree of accuracy e.g. stratigraphy, terrain. Shape from Structured Light was used for artefacts that require to be recorded to a higher degree of accuracy e.g. pottery, tiles
- Size of the artefact: Shape from Structured Light was used for those artefacts that could be moved out of the direct sun-light and into a laboratory e.g. pottery, tiles, small building block or large building blocks that had been moved into storage huts e.g. friezes, statues. Shape from Video or Stereo was used for large artefacts that could not be moved into a laboratory e.g. friezes, statues, building blocks
- Accessibility of the artefact: Shape from Video or Stereo was used whenever the artefact was too large to get close enough to record it otherwise e.g. buildings.
- Speed of recording: Shape from Video was used whenever there was a pressing race against time e.g. stratigraphy.

Table 1: Tool used for recording artifact

Object	Tool
Stratigraphy	Shape from Video
Pottery & Tiles	Shape from Structured Light in lab
Statues	Shape Structured Light in field/lab
Friezes	Shape Structured Light in field/lab
Buildings	Shape from Video Shape from Stereo
Capitals	Shape from Video
Cornices	Shape from Video
Terrain	Shape from Video
Texture	Texture Generator

4.1.1 Shape from Structured Light (Building Parts, Statues, Statue Parts, Pottery)

The Shape from Structured Light generates 3D models based on the use of a single image taken by an ordinary camera and is used to record pottery fig 4, movable artefacts fig 5 and friezes that were stored in warehouse fig 6. It is based on the principle of structured light: a predefined grid or pattern is projected on an object or a scene and is viewed at by a camera from a (slightly) different point of view. Alternatively a 3D flash unit which consists of a digital camera (Canon EOS D30) and a flash-light, projects the grid lines. Two laser pointers are added to help the user to determine the chosen fixed distance. A metal frame gives the structure its necessary rigidity, as shown in fig 3.

Characteristic for structured light techniques is that the 3D structure of the object can be deduced from the deformation of one or more grid projections. The use of these techniques is however restricted to very controlled lighting circumstances requires tedious calibration procedures and heavily depends upon the hardware used.

Structured light techniques rely on the fact that when a grid is projected onto an object and is looked at it with a camera from a slightly different point of view, the grid will look deformed. The visible deformation of the grid is related to the three-dimensional structure of the object.



Fig 3: 3D flash unit in rigid frame

The heart of the system is the Shape from Structured Light Slide that comes with the software package. This specially etched slide contains the pattern that needs to be projected onto the objects before they can be modelled. The slide can be inserted into the slide projector in any way. The orientation of the slide does not matter.

The slide basically consists of two orthogonal sets of horizontal and vertical lines. An original slide -- the master -- is produced i.e. etched using lithographic techniques on a glass plate. The slides that are commercially sold are chrome copies of the original master. The software to design the slide as well as the tools to control the machinery is made in house.



Fig 4: Sherd of Pottery



Fig 5: Poseidon



Fig 6: Dancing Girls Frieze

4.1.2 Shape from Stereo (Buildings, Building Parts)

The shape from stereo (photogrammetric) technique determines the shape and position of objects from a sequence of photographic images taken with a calibrated camera. The focus of photogrammetric recording is on high accuracy of the delivered 3D data.

To calibrate the system, the user takes 6-10 pictures of an indoor calibration target from different viewpoints. The system automatically detects and measures the markers on the target and computes the interior orientation parameters of the camera. When the user takes pictures of the object, all relevant parts of the object should be visible in at least 3 images, and the sequence of images should be dense enough to allow stereo matching.

After bringing the images back to the computer, they are automatically re-sampled to get rid of lens distortion. Then the relevant image content has to be interactively separated from the background and from unwanted foreground objects.

The image points are then matched to subpixel accuracy using a hierarchical area-based matching algorithm. A quality measure is computed for each matched point. The points are bucketed to image regions to ensure coverage of the object and the best points of each region are selected for relative orientation.

All cameras are oriented with respect to the first one in the sequence and approximate object points are computed. Then a bundle block adjustment with iterative outlier elimination is performed to improve the orientations. With

the final exterior orientations all matched image points are triangulated to a 3D object model.

4.1.3 Shape from Video (Stratigraphy, Buildings, Building Parts, Statues, Terrain Geometry)

The shape from video technique retrieves both the structure of a scene and the motion of the camera from an image sequence. Not only video but also sequences of photographs can also be used. The processing is in principle fully automatic, although a limited user interaction can allow a more robust and flexible use of the software tool. In a first step features are extracted and matched or tracked over consecutive images. Followed by a structure-and-motion algorithm, this step yields a sparse 3D reconstruction (i.e. the 3D features) and the path of the camera. These results are enhanced through self-calibration and bundle adjustment. To obtain a full surface reconstruction of the observed scene, the images are rectified so that a standard stereo algorithm can be used to determine dense disparity maps. By combining several of these maps, accurate depth is computed for every pixel. Using a volumetric technique, these are then integrated together to yield a single 3D surface. By making use of texture mapping photo realistic models can be obtained. A more detailed description of this approach can be found in [2, 3, 4].

The flexibility of the approach allows this technique to provide a solution for many of the 3D modeling demands found in archaeology. In the context of this project Shape from Video will be used to record and reconstruct stratigraphy fig 7, building parts fig 8, statues fig 9 and terrain geometry fig 10.

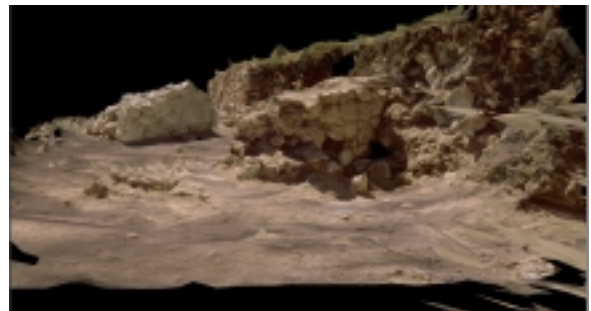

Fig 7: Stratigraphy



Fig 8: Two recorded pieces of the NW Heroon



Fig 9: Fortuna

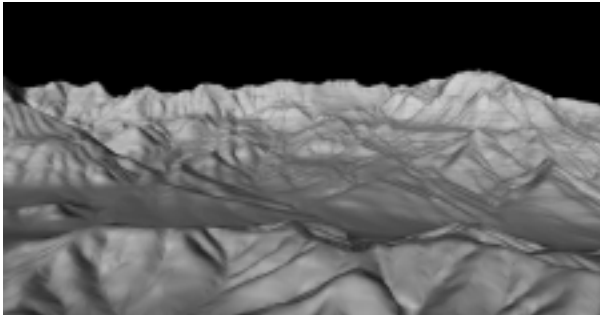

Fig 10: Sagalassos Terrain

4.1.4 Sokkia/Microstation (Stratigraphy)

For classical recording and drawing of stratigraphical and architectural features a combination of a total station with an electronic field book (Sokkia SET 4B/SDR33 Expert) and a drawing package (Microstation) is used. Of every uncovered stratigraphy feature a number of points is measured using the total station. These points are recorded in the electronic field book and downloaded at regular intervals to a PC containing Microstation. The points (x,y,z coordinates) are imported in Microstation. The resultant model can then be used for the introduction of controls into Shape from Video software or, as is still the case, for the plotting of sheets with points at the scale and orientation requested by the drawing teams for completion by hand in the field. Since the number of points for any given surface is much higher when manual completion is envisaged (by a factor of 100 or more), compared to the automatic system of 3D Murale, the intention is to reduce this manual procedure as much as possible.

Digitized contour lines from an analog map of Ağlasun valley were available and have been converted to a digital terrain model (DTM) using Microstation.

4.1.5 Synthetic Texture Generator (Terrain Texture, Material Texture)

A statistical texture description is used for constructing a model on the analysis stage. Such models are used then to generate synthetic textures [5]. The models with pair-wise interactions seem to reproduce main visual cues of the terrain textures having strong stochastic character, for

example grass or stones. Two cases can be separated for the task of recording.

The first case deals with the so-called flat or painted textures which can also be subdivided into homogeneous and non-homogeneous textures. These are textures that have relatively small roughness of the underlying 3D surface. For such textures the recording of only one example patch, as a rule, seen under the frontal view is needed. This single view is used then as an only input to the texture analysis procedure creating a texture model. The model is then saved in the database together with or instead of the example patch.

The second case deals with the so-called rough textures (sometimes referred to as 3D textures) having prominent changes in height (microrelief) of the underlying 3D surface. For such texture the recording of example patches for different views is needed as the visual appearance depends essentially on the viewing angle (self-occlusions, self-shadowing and other). The rougher is the texture, i.e., the stronger are its appearance changes, the denser should be the recorded views. They are all the input to the analysis procedure, which creates this time a multiview texture model. Together with the sets of statistical parameters of texture, the information about the orientation in the 3D space for each of the views is saved.

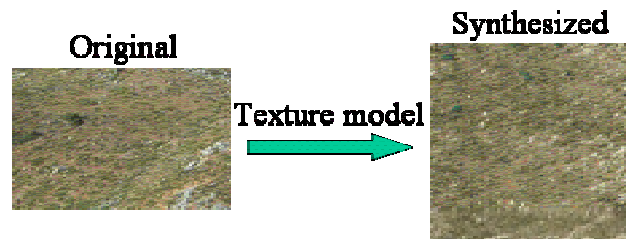

Fig 11: Leaning and Synthesis of Homogeneous Textures

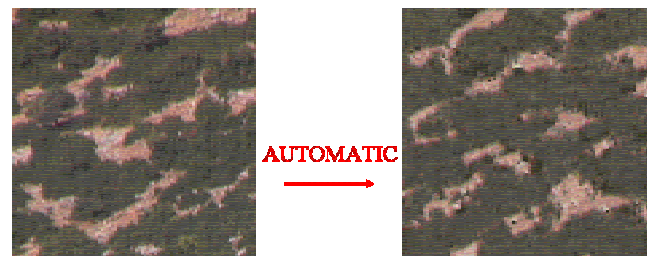

Fig 12: Leaning and Synthesis of Non-Homogeneous Textures

4.2 Reconstruction Tools

The choice of the reconstruction tool is given in table 2 and is entirely dependant on the type of artefact being reconstructed.

Table 2: Tool used for reconstructing artifact

Object	Tool
Stratigraphy	STRAT
Pottery & Tiles	Shape Matcher & Pottery Reconstruct
Statues	Shape Matcher + Maya
Friezes	Shape Matcher + Maya
Buildings	Shape from Video + Maya
Capitals	Shape from Video
Cornices	Shape from Video
Terrain	Shape from Video
Texture	Texture Generator

4.2.1 STRAT (Stratigraphy)

STRAT is a tool that allows archaeological legacy data of recorded stratigraphic dimensions, artefacts and finds to be entered. A 3D perspective of the graphical output of this tool shows embedded artefacts. This tool allows accurate hypothesis testing of stratigraphic relations. The "shape from video" tool will be used to record stratigraphic layers. The 3D surface from each layer is recorded using the tool. In order to correctly position the successive layers on top of each other reference markers with exact known world coordinates need to be placed on the stratigraphic layer. The options for placing reference markers within the scene for detection of corners of stratigraphy were studied in order to position/reconstruct stratigraphic layers correctly. Options for recognising these reference markers were also studied.

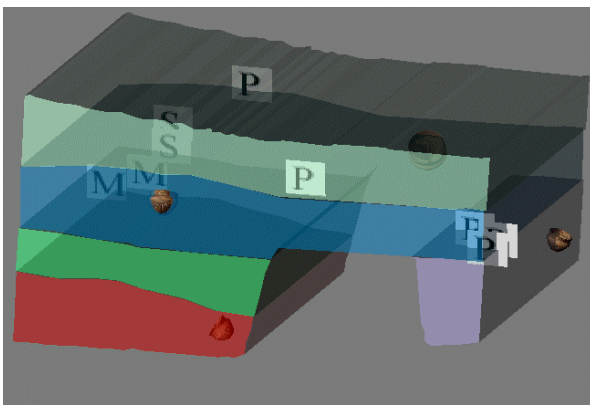

Fig 13: 3D perspective showing embedded artefacts

4.2.2 Shape Matcher (Building Parts, Statues, Pottery)

The Shape Matcher software is a tool to combine different patches in order to obtain a complete all-around 3D model.

It distinguishes itself from other approaches in the fact that:

- The matching procedure between different patches is automated and can be performed on more than two patches at the same time.
- There is no need for prior knowledge about the relative positions of the separate patches,
- Even patches that do not match perfectly or do not correspond can be integrated into a single surface.
- It takes into account specific information about the data acquisition (Shape from Structured Light's calibration file) to optimise the matching process.

An important part of the ShapeMatcher's interface is the 3D Viewer. The camera control resembles the one of the Shape from Structured Light but has been elaborated in a number of ways.

First of all the interface has been designed to allow to rotate, scale or move the set of patches as a whole or each of the patches relatively to one another within a 3D world frame. Each of the patches can be viewed in a different colour to make them easier to distinguish from one another. The number of colours used can be controlled in the preferences. All patches can be viewed in wire frame, shaded or textured mode.

An alternative way to initialise or set the relative position of each of the patches is based on the indication of corresponding points between two distinct patches. This part of the interface is 2d-based, as is the Shape from Structured Light, since there is a direct relationship between the point indicated on the 2d plane and the 3D coordinate on the surface. The resulting set of 3D points is used to determine the transformation that is needed to align the indicated points as close as possible, and thus to reposition the selected patches.

A thumbnail viewer of all the patches that are loaded in the software covers part of the interface. The thumbnail viewer allows selecting / adding or fixing a subset of patches on which the specific task needs to be performed.

The interface is crucial step in the modelling process since it allows one to put the different patches in their initial relative position, which is necessary to initialise the modelling process. From then on automatic tools can be called for: the matching proceeds in three consecutive steps:

- Alignment;
- Blending;
- Integration of the different patches into a single model.

4.2.3 Shape from Video (Stratigraphy, Buildings, Building Parts, Statues, Terrain Geometry)

See Section 4.1.2.

4.2.4 Enhanced Maya (Buildings, Statues)

The differences between the reconstruction processes for statues and buildings were analysed and found to be that reconstruction of statues involves few pieces with free forms and reconstruction of buildings involves many pieces with mostly regular geometric forms. Almost always a significant amount of pieces are missing, therefore hypothesis about these pieces enter into the reconstruction.

The process of reconstruction can therefore be divided into the following steps:

- Deriving the hypothetical building pieces from the real pieces recorded in site.
- Build a complete model with these hypothetical pieces.
- Identify the corresponding real pieces, if available.

A draft design for a digital reconstruction workflow was tested using Maya with the reconstruction of the Heroon. As a result the desired capabilities of a digital user interface for reconstruction were specified.

The analogue reconstruction drawings for the Heroon were converted to digital 3D data. Recording data from the Sagalassos site will be incorporated after this summer's campaign. A full description of the reconstruction process is described in [6].

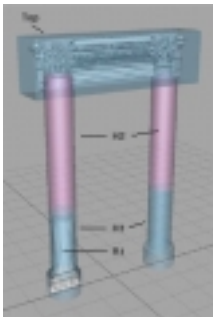

Fig 14: Scene for archaeology

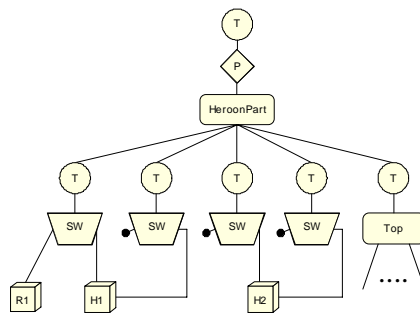

Fig 15: Scene graph for archaeology

4.2.5 Pottery Reconstruct (Pottery)

A tool that identifies different fragments belonging to the same vessel pre-classification rules is being developed [7, 8, 9]. One classification scheme works by the exploitation of so called 'extrema points' or points of variance (usually first and second derivatives). Using these points the relative ratios and distance of characteristic parts of the sherds could be measured and checked if they fit with a general classification scheme. Preliminary tests have been worked out on the restoration of a complete pot out of one of its fragments.

Another classification scheme is based on the shape, material and color. An approach is being developed for accurate colorimetric information of fragments, performed on digital images containing archaeological fragments

under different illuminants with a priori known spectral illumination. It is assumed that the spectral reflectance of archaeological fragments varies slowly in the visible spectrum. Colour measurements of fragments using a photospectrometer have been performed to achieve accurate colorimetric information and to get spectral reflectances of a set of fragments.

4.2.6 Synthetic Texture Generator (Terrain Texture, Material Texture)

A tool is being developed to restore texture. The restoration of texture requires synthesizing a patch of the required size using the model recorded on the analysis stage and probably under some environmental constraints. For the moment, the constraints mean simply that some neighbouring fragments were already synthesized and the new synthesizing patch must fit seamlessly into such environment. Successful experiments were done on seamless knitting of textures.

As the texture synthesis takes a longer time, the required patches of textures should be generated off-line and mapped during the visualization on the corresponding places of 3D surface. There should be two different mapping procedures. The first one is for the flat textures and the second one for the rough textures. In the first case for each fragment of the 3D surface a single synthetic patch of the flat texture will be used. In the second case for each 3D surface fragment there will be a set of synthetic patches, which correspond to the different views of the same rough texture. The real time visualization in the last case is still possible, as the experiment with the "on-the-fly" view substitution during the mapping has shown (made by GRAZ).

It will be necessary to have terrain models of the site at different epochs. These will be the same in large parts of the surroundings, but will differ considerably on the site itself. Furthermore the terrain model of the site must be changed, when new surveys are made with progressing excavation. However there is no guarantee, that the data is dense enough to obtain a satisfying representation of the terrain for all epochs. Therefore a tool was designed (and is currently being implemented), which allows to update parts of the terrain model, and to use information about the terrain form from one epoch together with height information of another epoch.

4.3 Visualisation Tools

The MURALE visualisation system addresses two different types of users:

- An archaeologist wants to focus on details and needs a very accurate visualisation of the finds such as pottery and statues. He/she does not need to be presented with a fully reconstructed virtual city, where all the buildings and objects are displayed as they could have

looked at a certain period of time. Therefore s/he is interested in a visualisation of the stratigraphic layers and the finds that were discovered within those layers, as shown in fig 16.

- Unlike the expert, the normal visitor needs some assistance in building up a hypothesis of how the city would have looked like in former times. He wants to see a complete reconstruction of the site, were all the gaps, left unclear by the excavation are filled in by a fictitious 3D model based on the expert knowledge of the archaeologists. Thus, for site-visualisation MURALE will develop a prototype for an interactive museum installation. In order to reach a broader public the site-model will also be accessible over the Internet. The sections 4.3.2 and 4.3.3 focus on these two issues in more detail.

Since the MURALE multimedia database also stores different kinds of annotations to objects, this additional information is used for visualisation. Representative objects are located within the scene that represents the class of objects found in the vicinity e.g. a particular type of vase or pot, etc. These objects have been annotated with a link to the database that contains all the artefacts, where other finds in the vicinity can be accessed. This content is also sensitive to different eras, i.e. only vases and pots of the selected era will be displayed and accessible.

A second requirement of the MURALE visualisation system is that users (visitors and archaeologists alike) will be able to navigate through time – i.e. by using a simple time slider. Especially visitors to a site are often confronted with a situation that is mainly the result of archaeological activities, which throughout the excavation have focused on different chronological periods in view of specific research questions. As a result, buildings that were never visible at the same time now figure next to one another. On the other hand, the final phase of a settlement also includes various buildings of much older date, which during the site's occupation have gradually been transformed, sometimes very drastically, so that their original shape and function can no longer be recognized. The site-visualisation tool will show the gradual transformation that the site and its environment underwent during the various phases of its occupation. For instance the transformation of pagan temples into churches and the incorporation of public buildings or space (e.g. squares, streets) into private structures will become visible.

4.3.1 STRAT (Stratigraphy)

The stratigraphic visualisation tool generates a textured or wire-frame 3D representation of the stratigraphic layering of archaeological excavations and provides plan, profile and perspective views to the data [10]. Artefacts discovered in a layer can be represented by a symbol or by a 3D representation of the found artefact, as shown in fig 16. Each layer can have an arbitrary shape. The tool:

- enables the archaeologists to more readily visualise the relative positioning of the stratigraphic layers
- selectively chooses a particular group of artefacts to be visualised within the stratigraphic layers for the purpose of analysis
- visualises each stage of the excavation using a time slider thus establishing the chronological sequence of stratigraphic layers
- visualises user defined cross sections of the stratigraphy
- highlights through visualisation the inconsistencies in the dimension of adjacent stratigraphic layers
- corrects through user interaction the inconsistencies in the dimension of adjacent stratigraphic layers

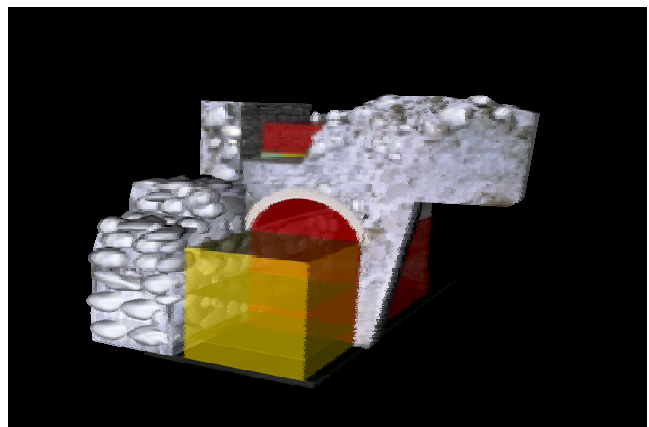

Fig 16: STRAT Tool Visualisation

4.3.2 Internet

In order to make the virtual site accessible to users all over the world, the model needs to be distributed in an internet-compliant way. Several choices exist ranging from a simple VRML-based scene that can be explored by today's standard web browsers to a customized plug-in offering functionality that is only relevant in the context of archaeology (e.g., the time slider).

When connected to the database using a slow dial-up connection, it is particularly important to reduce the amount of data to be transferred to a minimum. Early approaches [11] hierarchically organize the scene and provide versions of each object at different levels of detail (LOD). While this avoids the need to transmit the whole scene before the user can start to navigate, it increases the total amount of data and leads to distracting popping artefacts when switching between different representations of the same object. Unfortunately, this method is the only LOD-management incorporated into the VRML97 international standard.

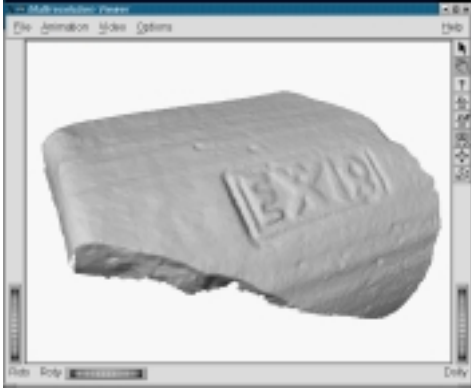

Fig 17: Plugin with LOD processing for Internet Browser

More powerful techniques provide a continuous LOD representation of the scene, from which the optimal geometric resolution can be obtained, for each viewpoint (see [12] for a recent method). Another way to reduce network load is to avoid transmitting redundant and irrelevant data. By exploiting topological and geometrical coherence, the size of a 3D model can be reduced dramatically [13].

Unlike in a controlled environment (see next section), no assumptions can be made about the user's hardware. Therefore the visualization system has to automatically adapt to the available bandwidth and graphics performance of the user's system to avoid long delays during interaction.

An algorithm based on [12] is currently being developed that also features database support and compression. The prototype has successfully been tested as a standalone application, but is going to be transformed into a browser plug-in for all major platforms to be used together with a standard web browser.

A preliminary plug-in incorporating LOD processing for an Internet browser has been developed and is shown in fig 17.

4.3.3 Standalone & Museums

Bandwidth is not of much concern in a museum installation, spatial scene organisation and the use of LODs still are important issues to overcome scene complexity – even when using state of the art graphics hardware. In this scene the work on Internet visualisation is also relevant for standalone and museum visualisation.

A high level of interaction is vital to attract the museum visitor. The use of virtual reality enables the user to actually walk through the ancient city in a very natural way. In order to avoid “motion sickness” images for both eyes need to be presented at a constant frame rate and the system’s latency when the user moves around should be low (within about 200 ms).

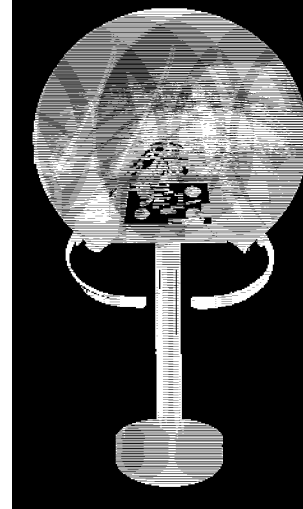

Fig 18: Elumens Cave mounted on a Navigating Podium

Often a visitor feels lost when the navigation through a complex 3D-model is completely unconstrained. He/she will be able to take different types of tours to explore the history of the ancient city. Besides by using predefined paths between major monuments and highlights the predictability of the visitor's trajectory is increased, which in turn leads to more efficient visualisation algorithms.

For instance, a virtual tour bus takes the visitor through the site while explaining the most important things. Like on a hop-on hop-off tour bus, the visitor gets off at interesting points and explores the site himself. Once done, s/he continues with the tour. The visitor can also take a thematic tour, which explains a certain object or cultural tradition. He could for instance take a path through the city up to the theatre. On the way to his destination the visitor learns more about Greek or Roman theatres.

Apart from the site model, different kinds of multimedia information such as photographs, movies, 3D animations, pre-computed camera animations and textual information will be included in the presentation. Navigateable panoramic images and movies, revealing either an actual or a hypothetical view on the excavation, will be linked with interesting spots in the scene.

An Elumens 1.5 metre cave mounted on a navigating podium is the visualisation system proposed for the museum visualisation system, as shown in fig 18 whilst preliminary visualisation systems are presented in [14].

4.4 Database Tools

A layered model will be used for the multimedia content in the database, as shown in fig 19.

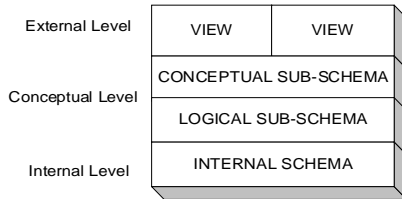

Figure 19: Layered Database Model

The External Level represents the user's view of the database. This level describes that part of the database that is relevant to each user. It is the first level of the ANSI/SPARC three-level architecture.

The Conceptual Level represents the community view of the database. This level describes what data is stored in the database and the relationships among the data. It is the second level of the ANSI/SPARC three-level architecture. The Conceptual Level comprises a Conceptual data model and a Logical Data Model.

The Conceptual data model is implementation independent and usually uses the semantic conventions of the Entity-Relationship Diagram proposed by Chen in 1976, however UML is becoming a popular alternative notation.

The Logical Data Model is implementation dependent. For example, the Relational Model, Network Model, Hierarchical Model and Object Model paradigms each implement the Conceptual data model in their own distinctive way.

Internal Level represents the physical representation of the database. This level describes how that data is stored in the database. It is the third level of the ANSI/SPARC three-level architecture. Typically, indexing issues are addressed at this level.

The database uses agreed file formats. For video, MPEG-2 will be used. For 3D vector and 3D vector/time formats VRML/MPEG-4 will be used and may be superseded by X3D. PNM family will be used for 2D pixel formats – to be compressed with *gzip* and the JPEG format will be used for *all* Web page images. PNM files to be converted to this format for presentation purposes. XML document formats to be used for all future documents. Authoring and conversion tools to be purchased where necessary. XHTML formats to be used for all Web pages.

The 3D MURALE database hardware configuration is shown in fig 20 and consists of three servers that are configured to work on either fast or slow Ethernet networks. The database adheres to the open source requirements of the archaeologists and thus utilises Linux operating system and the PostgreSQL database system.

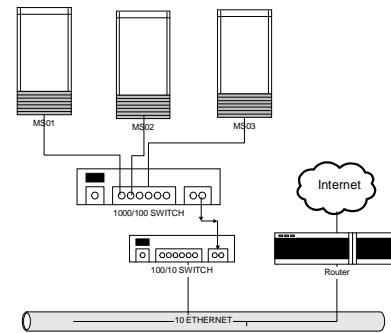

Figure 20: Layered Database Model

The four levels of the 3D MURALE database architecture are expressed by creating a data model at each level. An Entity-Relationship Diagram (ERD) is used to express the data requirements of the project. The design used the following principles:

1. Faithfulness: The design should be faithful to the specification of the application.
2. Avoid Redundancy: The design should be careful to represent anything only once. Care should be taken to duplicate data no more than is absolutely necessary.
3. Simplicity: Avoid introducing more elements into the design than is absolutely necessary.
4. Right Relationships: Entities can be connected in various ways by relationships. Care should be taken to create no more relationships than is absolutely necessary.
5. Right Elements: Create the right elements to model the real-world concept. Care should be taken to assign attributes to their correct element.

ERDs of the external and conceptual levels have been defined for the recording the archaeological excavation process, the building reconstruction and the pottery reconstruction processes.

The database will follow current CIDOC data model guidelines (CIDOC 1999) for representing the final museum artefacts. The work done in the 3D MURALE project may be used to extend the CIDOC data model to address the archaeological excavation process.

In the future, the Multimedia Database may evolve towards a multimedia XML database, using an XML document paradigm for its interface. The XML document abstraction is simple and powerful, allowing standardised access to the database. Both GUI and API interfaces will accept an XML Schema and XML document as input and will output an XML, XHTML or VRML document (Figure 21). The XML document interface to the MMDB database will support MPEG-7 Description Schemes for the description of recorded content wherever applicable.

A full description of the database system being developed is given in [15].

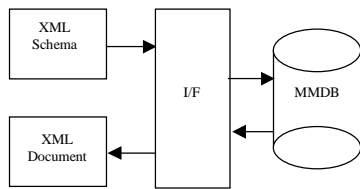

Figure 21: XML Document

5. Conclusions

This paper presents the EU funded project, 3D Measurement and Virtual Reconstruction of Ancient Lost Worlds of Europe (3D MURALE). It describes the set of low-cost multimedia tools for recording, reconstructing, encoding, visualising buildings, building parts, statues, statue parts, pottery, stratigraphy, terrain geometry/texture and material texture with a database for proper storage and retrieval placing the tools in the context of an overall multimedia concept for archaeology.

6. Acknowledgement

The authors gratefully acknowledge the support for this work that is funded by the EU under the IST program in the project 3D MURALE (3-Dimensional Measurement and Virtual Reconstruction of Ancient Lost Worlds of Europe), IST-1999-20273.

7. References

- [1] J. Cosmas,, T. Itagaki,, D Green, E. Grabczewski, M. Waelkens, R. Degeest, et al. "3D MURALE:A Multimedia System for Archaeology". Proc. ACM Virtual Reality, Archaeology and Cultural Heritage (VAST 2001). Nov 2001
- [2] M. Pollefeys , R. Koch, M. Vergauwen, L. Van Gool. Automated reconstruction of 3D scenes from sequences of images, ISPRS Journal of Photogrammetry and Remote Sensing (55)4 (2000), pp. 251-267.
- [3] M. Pollefeys, L. Van Gool, M. Vergauwen, F. Verbiest, J. Tops "Image-based 3D acquisition of Archaeological Heritage and Applications" Proc. VAST 2001 conference. Athens, Greece. November, 2001
- [4] M. Pollefeys, M. Vergauwen, K. Cornelis, F. Verbiest, J. Schouteden, J. Tops, L. Van Gool "3D acquisition of archaeological heritage from images", CIPA 2001 International Symposium, Potsdam. September 18 - 21, 2001.
- [5] A. Zalesny, D. Auf der Maur, L. Gool, "Composite Textures: emulating building materials and vegetation for 3D models" Proc. VAST 2001 conference. Athens, Greece. November, 2001
- [6] S. Hynst, M. Gervautz, M. Grabner, K. Schindler "A work-flow and data model for reconstruction, management, and visualization of archaeological sites" VAST 2001 Conference Glyfada, Greece Nov. 28-30 2001
- [7] M. Kampel., R. Sablatnig "Computer Aided Classification of Ceramics Proc. of Intl. EuroConference on Virtual Archaeology between Scientific Research and Territorial Marketing" Proc. VAST conference, November 25, 2000, Arrezzo, Italy, in press. Nov. 23-26th, 2000
- [8] K. Adler., M. Kampel., R. Kastler., M. Penz, R. Sablatnig., K. Schindler, S. Tosovic "Computer Aided Classification of Ceramics" -Achievements and Problems Workshop on Archaeology and Computers, Vienna, Austria. Proc. of 6th Intl. Workshop on Archaeology and Computers, in press. Nov. 5-6th, 2001
- [9] M. Kampel, R. Sablatnig "Automated 3d Recording of Archaeological Pottery" Cultural Heritage and Technologies in the Third Millennium, Milan, Italy. Proc. of Intl. Conf. On Cultural Heritage and Technologies in the Third Millennium, Vol. 1, pp. 169-182, Sept. 2001. Sept. 3-7, 2001
- [10] D. Green, J. Cosmas, T. Itagaki, E. Grabczewski, M. Waelkens, R. Degeest et al., "A Real Time 3D Stratigraphic Visual Simulation System for Archaeological Analysis and Hypothesis Testing". Proc. ACM Virtual Reality, Archaeology and Cultural Heritage (VAST 2001) Nov 2001.
- [11] M. Brandli.: A Triangulation-Based Method for Geomorphological Surface Interpolation from Contour Lines, *In* Proceedings of EGIS 1992, München 1992, S.691-700
- [12] J. H. Clark. Hierarchical Geometric Models for Visible Surface Algorithms, Communications of the ACM, 19(10) 1976, pp. 547-554.
- [13] J. El-Sana and Y. Chiang. External Memory View-Dependent Simplification, Proceedings Eurographics, Computer Graphics Forum 19(3) 2000, pp. 139-150
- [14] M. Pollefeys, L. Van Gool, I. Akkermans, D. De Becker. "A Guided Tour to Virtual Sagalassos" Proc. VAST 2001 conference. Athens, Greece, November, 2001
- [15] Grabczewski, E, Cosmas J, Van Santen, P, Green, D, Itagaki, T et al. "3D MURALE: Multimedia Database System Architecture". Proc. ACM Virtual Reality, Archaeology and Cultural Heritage (VAST 2001). Nov 2001