

# Fiber-Fiber Bond Formation and Failure: Mechanisms and Analytical Techniques

*U. Hirn*<sup>1,3</sup> and *R. Schennach*<sup>2,3</sup>

<sup>1</sup>Inst. for Pulp- and Paper Technology, Graz University of Technology, Austria

<sup>2</sup>Inst. of Solid State Physics, Graz University of Technology, Austria

<sup>3</sup> CD-Laboratory for Fiber Swelling and Paper Performance

## ABSTRACT

In this paper we give a literature overview on three different aspects of pulp fiber-fiber bonding. First we are reviewing how the adhesion between the pulp fibers is created by the capillary pressure during drying of a sheet. Second we are discussing the individual mechanisms relevant for fiber-fiber bonding. They can be grouped in three different groups: (a) The area in molecular contact, which also includes interdiffusion. (b) the intermolecular bonding mechanisms hydrogen bonding, van der Waals forces and Coulomb interaction. (c) the mechanical bonding mechanisms which are capillary bridges and mechanical interlocking. The third and last part of the review discusses the failure process of fiber-fiber bonds and related single fiber-fiber bond testing methods. The general emphasis of the paper is set on providing a general understanding of the processes responsible for how bonds between fibers are created, how they work and how they are failing.

## 1 INTRODUCTION

The question which mechanisms are holding paper fibers together has been discussed for a long time, more recent literature reviews are given in [1, 2, 3, 4]. The aim of this paper is to give an overview on the processes taking place during development, existence and failure of fiber fiber bonds. Emphasis is put on a qualitative understanding of the fiber-fiber bonding- and bond failure procedure rather than on a quantitative analysis [5] of the individual bonding mechanisms.

A prevalent opinion still is that the adhesion in fiber-fiber bonds is caused by hydrogen bonding. However, it has also been proposed [1] that there are several

bonding mechanisms that play an important role. Three of these mechanisms are interactions between surfaces on a molecular level, namely *hydrogen bonding*, *Van der Waals forces* and *Coulomb bonding* (electrostatic interactions between ionic species). Hydrogen bonding and Van der Waals forces only take place when the bonded surfaces are having a distance below a few Ångstrom. Regions close enough are thus forming the so called *area in molecular contact*, i.e. the region where all intermolelucur bonding mechanisms can actually take place. *Interdiffusion* is a mechanism which increases the area available for inter molecular adhesion forces. In addition to these mechanisms taking place on the nanometer scale there are two other mechanical mechanisms contributing to fiber-fiber bonding on the micrometer scale, *mechanical interlocking* and *capillary bridges*.

In the following we will discuss how a bond between two individual fibers is created and the relevance of the area in molecular contact will be discussed. Then the individual bonding mechanisms will be reviewed followed by insights into the fiber bond failure. Finally conclusions and future challenges will be defined.

## 2 AREA IN MOLECULAR CONTACT

The interaction range for some of the molecular adhesion mechanisms like hydrogen bonding or Van der Waals forces is in the range of a few Ångstrom. Thus it is necessary to determine the contact area between bonded fiber surfaces on the Ångstrom size scale. In Figure 1 one can see that upon zooming in on the interface between two surfaces one will find non-bonded regions with increasing zoom. Regions that seem to have full contact may be separated under larger magnification. The actual area in molecular contact is the contact area at Ångstrom scale, i.e. the magnification that is able to resolve the relevant distance for short-distance molecular interactions. In this section we will first discuss the mechanism that brings the fiber surfaces close enough that molecular interaction occurs and the surface properties governing the area in molecular contact, an in-depth review on this topic gives [6]. Then the rather controversial literature on the actual degree of molecular contact in fiber-fiber surfaces is reviewed.

### 2.1 Obtaining adhesion between fiber surfaces

The degree of contact between surfaces on a molecular level is described by contact mechanics. Contact mechanics are relevant for phenomena like friction [8], sealing [9] and adhesion [7]. During the last years quantitative analysis of molecular contact area using different contact mechanics models has received increasing attention [10, 9, 11, 12].

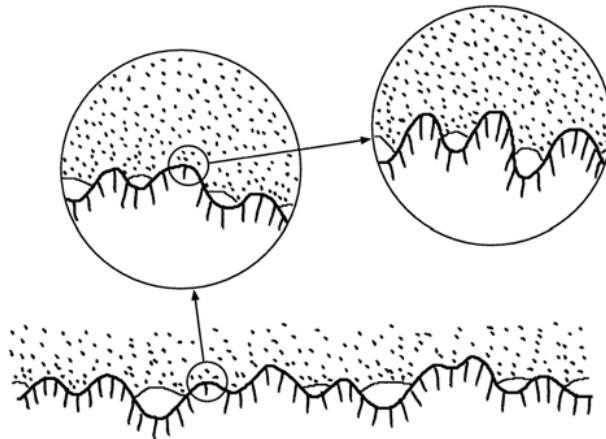

**Figure 1** The contact area between two surfaces changes upon zooming into the interface [7]. Regions that seem to have full contact may be separated under larger magnification.

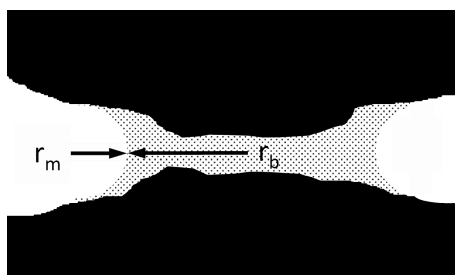

**Figure 2** A capillary bridge of water between two fiber surfaces. The Laplace pressure due to the capillary force is shown in Equation 1.

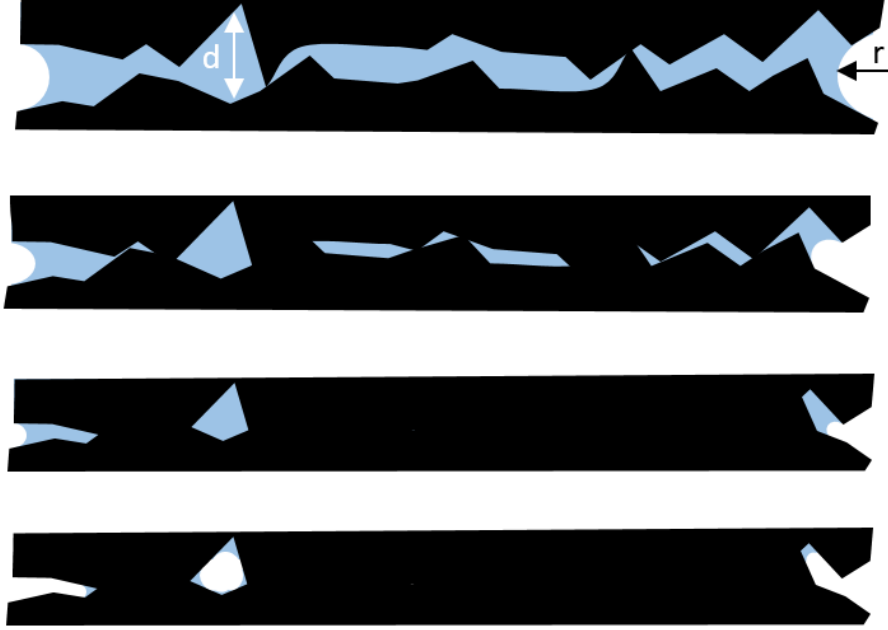

**Figure 3** The capillary pressure during drying is pulling the fiber surfaces into contact (top to bottom image). As the water is removed the meniscus (R) of the capillary bridge decreases, increasing the Laplace pressure. The capillary pressure is promoting contact, surface roughness and material E-modulus are inhibiting contact.

In paper fibers the driving force to establishing molecular contact [13] are capillary forces, the same forces that are also responsible for paper wet web strength [14]. The capillary forces in paper are created by bridges of water between the fiber surfaces, figure 2. The meniscus in the capillary bridge is causing an adhesion pressure, the so-called Laplace pressure  $p$

$$p = \gamma \left( \frac{1}{r_m} + \frac{1}{r_b} \right) \approx \frac{\gamma}{r_m}. \quad (1)$$

The Laplace pressure  $p$  is determined by the air-water surface tension  $\gamma \approx 70$  mN/m and the two radii of curvature (m) in the meniscus  $r_m$  and  $r_b$ . As generally  $r_b \gg r_m$  equation 1 can be approximated by  $\frac{\gamma}{r_m}$ . The key parameter determining the Laplace pressure pressing together the fiber surfaces is the distance between the surfaces  $2r_m$ . Large capillary forces occur if the distance between the surfaces is low and the resulting meniscus  $r_m$  of the liquid is small.

Figure 3 illustrates how molecular contact between two fiber surfaces is established. The driving force for contact development is the Laplace pressure due to the capillary bridges. When the two surfaces are touching the peaks of both surface topography profiles are increasingly deformed. This deformation leads to

a force counteracting the force pressing the surfaces together, the degree of contact between the surfaces is determined by the equilibrium between these forces. When the water is retracting the menisci in Figure 3 are moving inwards, thus decreasing the radius  $r$  which, according to equation 1, increases the capillary pressure. So the capillary bridges become *stronger* as the water is removed between the fibers. This leads to an increase in the contact area and, at the same time an increase of the Laplace pressure because the reduced surface distance further decreases the radius  $r$  of the meniscus. The smoother the surface the smaller the menisci, and the stronger the Laplace pressure becomes. Consequently the degree of molecular contact between the fiber surfaces is determined by two factors. High surface smoothness and low stiffness (E-modulus) of the surface material promote molecular contact. One can imagine that very soft and smooth surfaces may even develop full molecular contact when pressed together by the capillary forces. However as the surface gets increasingly rough (or stiffer) there are regions that cannot be pulled in contact by the capillary forces, the force to deform the surfaces to full contact is larger than the Laplace pressure. So for a given material stiffness there is a critical distance between the fiber surfaces, if the combined surface topography of the fibers exceeds this critical distance no molecular contact between the surfaces will occur. This is illustrated by the region with distance  $d$  in Figure 3. In this region the gap between the surfaces is too large to be overcome by the capillary forces. A detailed discussion on the mechanisms outlined above can be found elsewhere [6, 8, 7, 15]

In conclusion this means that for a given stiffness of the fiber material there is a certain *critical distance* which is overcome by the Laplace pressure during drying. If the fiber surface topography is not exceeding this critical distance there is full molecular contact between the fibers, i.e. 100% of the fibers surfaces are actually in molecular contact. If the surface is rougher, some fraction of the surface that appears to be in contact under lower magnification actually is not having full molecular contact.

## 2.2 Measuring the area in molecular contact

Measurement of the area in molecular contact in fiber-fiber bonds is difficult. A detailed review and discussion on the various approaches and methods is given in [6], here we give a brief overview. As explained in the previous section, even if contact is observed between two surfaces at a given magnification it may very well turn out that a measurement under higher magnification reveals that there is only partial contact. This is particularly a problem for all imaging based measurement techniques, because the imaging resolution is limited by half the wavelength of the radiation used in the imaging process. For light microscopy techniques the limiting resolution is half the wavelength of light, about 200nm. Furthermore,

surface gaps smaller than this distance are not affecting light traversing through the fiber-fiber bond. This leads to the situation that all light optical methods investigating the contact area in fiber-fiber bonds are not able to spatially resolve the area in molecular contact on a sub micrometer scale. Nevertheless, they provide valuable tools to inspect the bonded region on a larger length scale. Most relevant here is polarized light microscopy [16, 17, 18] and sectioning methods [19]. Higher resolution analysis is possible with x-ray micro tomography [20, 21] due to the lower wavelength. Contact on the nanometer scale has only been evaluated qualitatively using TEM [22] or in terms of relative differences [23, 24] using FRET microscopy.

For a contact model based analysis of the area in molecular contact in fiber fiber bonds [25, 6, 15] first, the surface roughness of the two interacting surfaces needs to be measured. Second, the surface hardness needs to be evaluated. Based on these two input parameters the contact mechanics model can be used to calculate the area in molecular contact. This was done in [25, 15] using surface roughness data obtained from AFM measurements and surface hardness data obtained from AFM based nanoindentation [26].

Results for the contact area in individual fiber-fiber bonds are not conclusive. Results for unbleached softwood kraft pulp fibers were reported to have a high degree of contact [19, 17, 27] using light microscopy and contact mechanics simulations of one group [25]. Also strength testing of single fiber-fiber joints manufactured with different drying pressure indicate a high, maybe even full degree of molecular contact in softwood kraft pulp fiber bonds [6]. However low degrees of molecular contact were reported from x-ray nanotomography [21] and from contact mechanics simulations of another group [15].

Clarifying the degree of molecular contact in fiber-fiber bonds is a key factor in understanding and improving fiber-fiber bonding and thus paper strength for low density paper grades. If it turns out that there is in fact only a low degree of molecular contact in fiber-fiber bonds, then improving fiber bonding is probably most efficiently addressed by improving the molecular contact area between fibers. If it is found that the degree of molecular contact is high, close to full contact, there is only little room for improvement there. Then other approaches must be sought, like increasing interdiffusion or trying to tap the potential of strong intermolecular mechanisms like Coulomb interaction.

### 3 BONDING MECHANISMS

In section 4 we will be showing and discussing in detail that the fiber-fiber bond failure process is *not* governed by the specific bond strength (strength per unit area) but instead it is governed by the *fracture toughness*, which is the energy

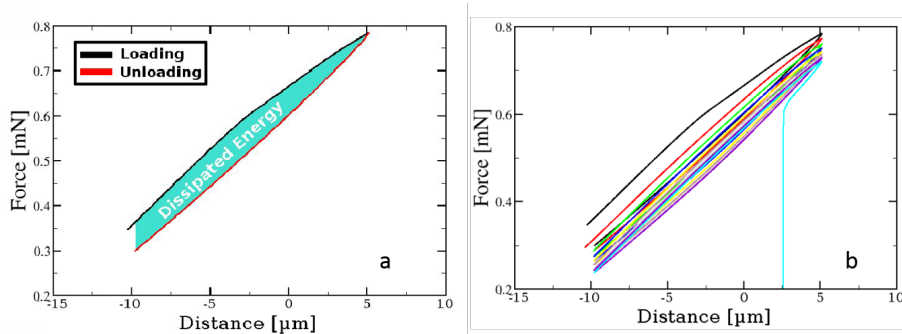
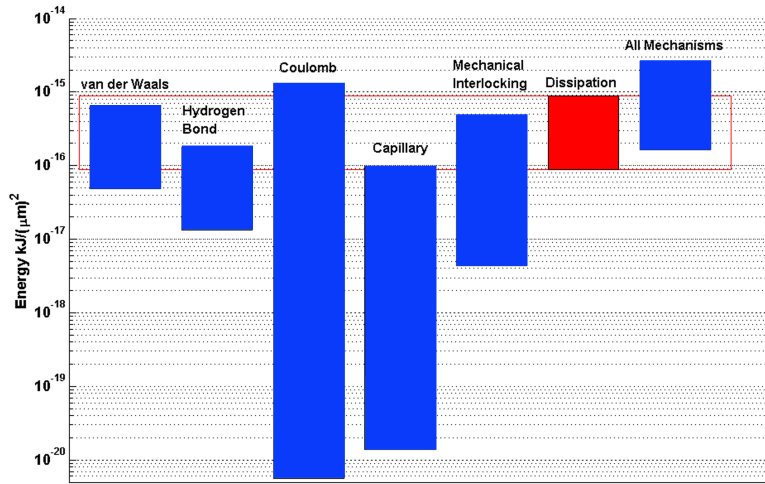

**Figure 4** Force distance curves measured by mode 1 experiments using an AFM. (a) single experiment, (b) cycled experiment (adapted from [28]).

consumed to grow a crack in the bonded region. We thus believe that the bonding energy of the adhesion between the surfaces is a much better parameter describing bond strength than the frequently used specific bond strength. This is why the bonding mechanisms are consequently analyzed in terms of bonding energy.

By cyclic loading and unloading of an individual fiber bond the energy dissipated between loading and unloading can be measured. All the elastic energy stored during loading is released during unloading, thus the dissipated energy corresponds to the area between the force-distance curves for loading and unloading. The cyclic loading can be repeated until the fiber bond fails. Figure 4 shows the loading-unloading curves for a mode 1 testing setup for fiber-fiber bonds [28]. Such experiments can also be done in mode 2 and mode 3 configurations [29]. The such measured dissipated energy is the sum of the bonding energy plus the energy consumed by plastic and viscoelastic deformation of the fibers, the bonding energy thus is *lower* than the dissipated energy. Nevertheless measurement of the dissipated energy gives an upper bound for the bonding energy.

The experimentally derived values for dissipated energy now can be compared to a quantitative model of the bonding mechanisms. Such an approach was used in [5]. Here the bonding mechanisms proposed in the literature earlier [1] were investigated in terms of their quantitative contribution to the overall bonding energy. The results are shown in figure 5. Please note that the uncertainties are large. Coulomb-, Van der Waals- and hydrogen bonding seem to have the strongest contribution to the overall bond energy followed by mechanical interlocking. However, Coulomb bonding has a particularly high uncertainty. According to figure 5 hydrogen bonds and capillary bridges play a less important role. The sum of all the mechanisms is quite well comparable to the overall energy dissipation for separating a bond. As this energy dissipation is also including plastic and viscoelastic deformation during the mechanical testing it becomes clear that the calculated value is higher than the actual bonding energy.



**Figure 5** Contributions of the different bonding mechanisms to the bond energy of a single fiber bond. The height of each bar represents the uncertainty. The red part shows the experimental results from mode 1 measurements (adapted from [5]).

### 3.1 Interdiffusion

In contrast to [1] where interdiffusion is listed as one of the bonding mechanisms, it is missing in Figure 5. This is due to the fact that interdiffusion is increasing the area in molecular contact. This effect was added to the uncertainties given in [5]. Interdiffusion will happen when polymer chains partly diffuse in the bonding region from one surface into the other. This is facilitated by the fact that the fiber surface in the wet, swollen state actually can be considered as a swollen hydrogel [30]. Interdiffusion has already been mentioned a rather long time ago [31], some authors even believe that this is the key mechanism for fiber-fiber bonding [32]. A literature review on this topic is given in [2].

Recently the effect of interdiffusion on adhesion energy was directly measured for PCL-grafted cellulose spheres using atomic force microscopy in colloidal probe mode. A time dependent increase in bonding energy and bonding force was found, stabilizing after roughly 10 seconds [33]. Interdiffusion, like the area in molecular contact, is a multiplier to the inter-molecular bonding mechanisms of Van der Waals forces, hydrogen bonding, and Coulomb interaction. It increases the contact surface between the fibers and thus the area of molecular interaction. The well known relation between increased fiber swelling and stronger bonding [34] can also be interpreted as an effect of interdiffusion. Higher dilution in the gel layers leads to faster interdiffusion, thus creating a larger surface for



**Table 1** Energies of hydrogen bonds, Van der Waals bonds and Coulomb bonds.

Bonding mechanism	Bond Energies for one individual bond in [kJ], taken from [5]
Van der Waals	$6.8 \times 10^{-24}$ for cellulose molecules from DFT
Hydrogen Bond	$1.9 \times 10^{-23}$ from DFT
Coulomb	$1.2 \times 10^{-20}$ between $\text{COO}^-$ and $\text{Na}^+$

molecular interaction between the surfaces. There are several publications dealing with the diffusion of polymers. The diffusion process strongly depends on the molecular weight and generally two different diffusion regimes for high and for low molecular weight are proposed. More details about polymer diffusion can e.g. be found in [35, 36, 37, 38]. Stadlmeier and Köhler [38] for example give a thermal and a mass diffusion coefficient for long polymer chains of  $13.76 \times 10^{-12} \text{m}^2/\text{sK}$  and  $1.36 \times 10^{-10} \text{m}^2/\text{s}$ , respectively.

Thomson et al. have adapted Förster Resonance Energy Transfer (FRET) microscopy for analysis of cellulosic fiber-fiber surfaces. FRET is a technique capable to quantify the degree of molecular contact (10 Å to 100 Å) between two surfaces. They studied the degree of contact of individual fiber-fiber bonds from pairs of viscose fibers and pulp fibers [23]. Furthermore, they analyzed the development of bonding during drying [39] and due to pressing [24]. For individual softwood pulp fiber-fiber bonds they found an increase in the FRET signal [39] which they attributed to interdiffusion of the surface molecules.

Interdiffusion might be an important binding mechanism, as it increases the molecular contact and therefore the microscopic bonding mechanisms (Van der Waals, Hydrogen Bonds, Coulomb interaction). However, it needs a lot more experimental research in order to get an at least semiquantitative value of its contribution to the overall bond strength. As the degree of interdiffusion seems to depend on the polymer chain length it will depend on the diffusing species (cellulose, hemicellulose, lignin) making quantitative statements even harder. Overall, it is unclear if diffusion is playing a relevant role for the industrial papermaking process as dewatering is taking place there rather very quickly, which could inhibit significant interdiffusion.

### 3.2 Hydrogen bonds and Van der Waals bonds

Hydrogen bonding has for decades been viewed as the most important binding mechanism in paper [40]. As sugar polymers have quite a lot of OH - groups this notion is not surprising. However, recent calculations of the bonding energy have identified Van der Waals forces as the most important bonding mechanism, Fig-

ure 5. When looking at table 1 we see that the difference in the bonding energy for individual bonds between Van der Waals bonds and hydrogen bonds is only about a factor of 3. Considering a cellulose unit cell it can be seen that there are 4 hydrogen bonds along the 010 surface [5]. Van der Waals interaction occurs between all atoms, thus there are 41 atoms per unit cell which can interact via van der Waals. Additionally Van der Waals is a more far-reaching interaction than hydrogen bonding. The Van der Waals interaction force between two atoms is proportional to  $1/r^6$ ,  $r$  being the distance between the particles. For two flat surfaces approaching each other the van der Waals force-distance relationship according to Lifshitz theory is proportional  $1/r^3$  [8]. In contrast, hydrogen bonds are very local interactions with hydrogen bonding distances between water molecules of about 0.18 nm, the force distance relationship, however, is proportional to  $1/r^3$ , as hydrogen bonds can be regarded as interactions between permanent dipoles. Accordingly calculations then lead to the result that, assuming single crystalline cellulose surfaces, Van der Waals is the more important bonding mechanism [5]. From recent studies of the crystalline structures of cellulose several other groups also argue that Van der Waals interactions are more important than hydrogen bonding between cellulose molecules in the crystalline structures [41, 42, 43, 44].

The role of hydrogen and van der Waals bonding has also been investigated experimentally. Recently, Przybysz et al. [45] argued in favor of hydrogen bonding. They conducted handsheet forming using water and increasingly apolar alcohols as solvents, paper strength increased with increasing polarity. The authors conclude that the reduction in paper strength is due to a decrease in the energy of hydrogen bonds between the fibers due to the decreasing polarity of the solvents and claim that their results reflect the prevalent importance of hydrogen bonding for the adhesion of pulp fibers in paper. One can also, however, explain the effect of changing the solvent also in terms of reduced swelling and reduced softness of the fiber surface. As discussed in the section on area in molecular contact, reduced fiber swelling leads to a harder surface which impedes the formation of a large molecular contact area between the fibers, which leads to the well known correlation between fiber swelling (in terms of fiber saturation point) and paper strength [34]. In fact in the work of Przybysz et al. the swelling decreased continuously with increasingly apolar solvents [45], which lead to the reported loss in strength. Additionally the stiffer fibers caused higher bulk [45], which also leads to decreased paper strength.

Other experimental investigations on the relevance of polar and apolar interaction for fiber-fiber bonding has been conducted by Pelton [46]. He had modified dry strength agents like starch by substituting an increasing amount of apolar groups to the molecules. With decreasing polarity of the molecule, also the paper strength was decreasing [46]. As a consequence he concluded that a higher degree of polarity of the strength agent is beneficial for paper strength. Please note that

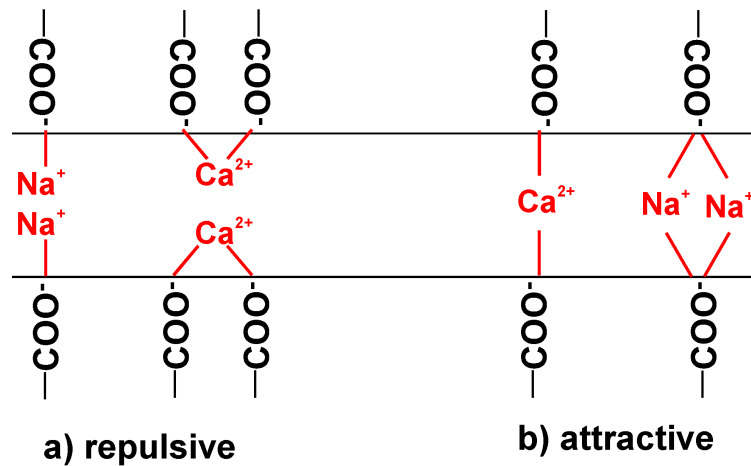

**Figure 6** Sketch of the possible configurations of charged species in the bond between two paper fibers (adapted from [5]).

these results are not an effect of different retention on the fiber surface, as this was controlled in the experiment [47]. Their findings are in alignment with the application of debonding agents. These chemicals are used to reduce fiber bonding e.g. in the production of fluff pulp or for increased tissue softness. Debonders are usually surfactants where the polar part is attached to the fiber surface and the apolar part apparently impedes the fiber-fiber bonding, compare [48].

The findings whether hydrogen bonding or van der Waals forces are more relevant for fiber-fiber bonding are overall inconclusive. While theoretical analysis consistently suggests that Van der Waals forces are more relevant experiments with dry strength agents are suggesting that higher polarity is beneficial for fiber bonding. Again the question arises, if this is a *direct effect* i.e. an indication that hydrogen bonding is the effective mechanism, or if higher polarity leads to a higher degree of molecular contact (stronger swelling and better interdiffusion) between the surfaces.

### 3.3 Coulomb Interaction

Coulomb bonds between paper fibers have their origin in the acid functions (carboxylic groups) that are found on hemicelluloses. In the basic conditions during kraft pulp productions these acid functions dissociate and the fibers retain negative charges. At least partial dissociation will also take place at lower pH values. Of

course paper is electrically neutral, which is due to cations from the solution that attach to the acid function and compensate the negative charges of the fibers [34]. If the charged species on the fibers in a fiber bond are in the right geometry they will lead to strong bonds, as Coulomb interactions are very strong (three orders of magnitude stronger compared to Van der Waals and Hydrogen bonds; see table 1). In addition, Coulomb interactions are far reaching, as the force decreases with  $1/r$ . However, the geometry can also be unfavorable if two positive or two negative charges come close together in the bonded area. This is shown in the sketch in figure 6. Both, repulsive [13] and attractive [49] Coulomb interaction has been reported.

Charged species in the pulp fibers play an additional role beside forming Coulomb bonds, they are highly relevant for fiber swelling. As discussed above fiber swelling is strongly associated with surface hardness and therefore with the area in molecular contact. This connection was also discussed in [50] where cellulose films with and without Xylan were swollen in different aqueous solutions. In [50] it is clear that Coulomb interactions increase swelling (softening the surfaces which increases the area in molecular contact) and induce stronger bonding (due to the electrostatic interactions of the charged species). There have been many discussions if charged species really increase bond strength by Coulomb bonding, or if they only increase swelling [1, 51, 13]. It was shown on viscose fibers that one can distinguish between the impact of swelling and the impact of Coulomb interactions [49]. In this paper it was shown that a pure viscose fiber swells as much as a viscose fiber containing cationic charges. However, while the viscose fibers did not form a bonded sheet the viscose fibers containing cationic charges formed sheets with a breaking length of about 500 m [49]. In the same work it was also shown that two viscose fibers with different amounts of added negative charges showed rather similar swelling. However, the viscose fibers with the higher amount of negative charges showed a significantly higher breaking length as compared to the fiber with less negative charges [49]. These results make it clear that charged species not only increase swelling they also lead to significant bonding due to attractive Coulomb interaction. Also Laine and coworkers [52] showed that a high surface concentration of carboxyl groups increased the specific fibre-fibre bond strength, in their case they created it by grafting CMC on the fiber surface.

Figure 6 shows that carboxylic groups must be present on *both* surfaces to enable Coulomb bonding. Assuming random distribution on the surface a first order approximation for the probability for a Coulomb bond is the squared surface coverage of carboxylic groups [5]. In the literature there are large differences in the reported values for the surface charge of pulp fibers, compare [53, 54, 55]. These large differences in surface charge lead to a huge uncertainty in the contribution of Coulomb interaction in Figure 5. Furthermore it is unclear if, and if

yes to what extent, besides attractive Coulomb interaction there is also repulsive Coulomb interaction taking place between fiber surfaces, as sketched in figure 6.

The fact that the carboxylic groups are promoting fiber swelling leads to the situation that the ionic strength (salt concentration) of the surrounding liquid has an impact on fiber-fiber bonding. If the concentration of charged species in the solution is higher than in the swollen fibers, osmotic pressure will lead to deswelling of the fibers. This will lead to an increase in surface hardness (see e.g. [50, 56]) which will decrease the area in molecular contact leading to less bonding.

We can conclude that carboxylic groups on the fiber surface lead to increased bonding between the fiber surfaces. They are promoting two bonding mechanisms which are contributing independently: increased swelling leading to an increased area in molecular contact and predominantly attractive Coulomb interaction.

### 3.4 Mechanical Interlocking

Mechanical interlocking is not a bonding mechanism on a molecular scale, it is taking place on the micrometer scale. It refers to the idea that the surfaces of the bonding fibers are mechanically entangled, which leads to an increase in bonding strength between the fibers.

This type of entanglement is mostly taking place by fiber surface fibrils produced by refining of the pulp. The formerly bonded area of fiber-fiber joints looks different for refined and unrefined fibers, see Figure 7. For unrefined fibers it is fairly smooth, while for refined fibers broken fibrils are found in the bonding region. Investigation of the strength of individual fiber-fiber joints for refined and unrefined fibers are supporting the idea of mechanical interlocking. For mode II testing of softwood fiber joints an increase of bonding force has been found regularly for refined fibers compared to the unrefined ones. The increase was 15% for Saketi [58], up to 50% for Jajcinovic [59], 20% for Mayhood et al. [60] and finally 8% for Stratton and Colson [61]. For some of these results the increase was statistically not significant, however the trend is consistent. Also for mode I testing a higher bonding force was found for refined fibers [62].

Please note that Figure 7 is *not a direct evidence* for mechanical interlocking as strong bonds from unrefined fibers also show fibril bundles torn off the surface, similar to refined fibers [61]. However, it is likely that the mechanism of strength increase in refined fiber-fiber bonds indeed is entanglement of external fibrils rather than increased area in molecular contact or interdiffusion.

Sometimes in publications on fiber-fiber bonding the bonded fiber surface is sketched as having considerable roughness on the micrometer scale [1, 63] which might lead to the idea that mechanical interlocking could also be promoted by the surface roughness. High resolution LVSEM imaging of the formerly bonded area

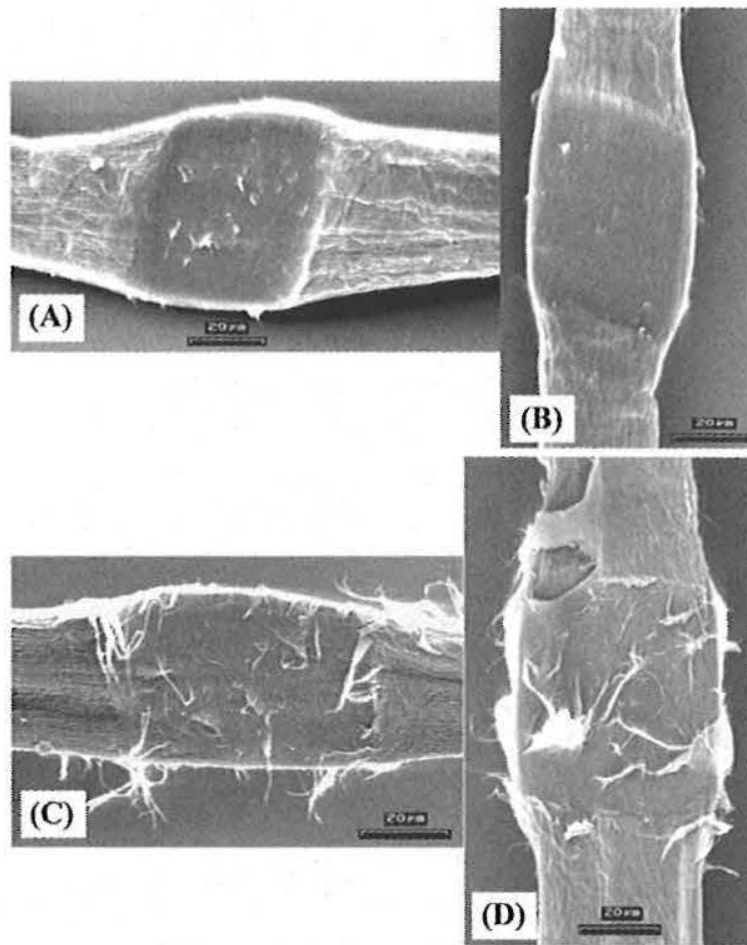

**Figure 7** The bonding surface of individual fiber-fiber joints after breaking [57], unrefined (A, B) and 30 minutes Valley beating (C, D). For the refined fibers fibrils have been torn out of the fiber surface during breaking of the fiber-fiber joint.

of broken fiber-fiber joints [64] however reveals that the surfaces are fairly smooth on the micrometer scale. This does not rule out entanglement due to roughness on the nanometer scale, nevertheless on the micrometer scale this mechanism is not playing a relevant role.

### 3.5 Capillary Bridges

Capillary bridges will play an important role during bond formation as has been shown above in the discussion about the area in molecular contact. However, capillary bridges could also contribute to paper strength in 'dry' conditions. The main reason for that is that pulp fibers at a relative humidity of 50% actually has a water content between 6% and 8% [3]. This is enough water to still form capillary bridges. As the water is removed from the fiber surface the Laplace pressure bringing the two surfaces together in a capillary bridge increases because the radius  $r_m$  decreases, compare equation 1. Molecular dynamics simulations [65] suggest that the equation for the Laplace pressure still holds for very thin water films in the range of a nanometer, which for water leads to a capillary pressure around 70MPa. Such capillary bridges, even when they increase the contact area between the fibers only a little, can significantly increase the adhesion between surfaces [66]. It is quite likely that capillary bridges are persisting through the drying section, because the vapor pressure over a curved surface (in this case the capillary bridge) increases according to the Kelvin equation [25, 66]. This leads to the effect that capillary bridges with very small capillary radius are not evaporating under low vapor pressure. Also from high vacuum technology it is known that even in the presence of ultra-high vacuum for long time there is still water present on solid surfaces. One reason is the high sticking coefficient of water on hydrophilic surfaces, e.g. [67]. This is the reason why water vapor limits the obtainable vacuum in high vacuum systems [68].

Considering the above it is not unlikely that capillary bridges also contribute to fiber-fiber bonding in dry paper. Empirical evidence has yet not been given to confirm this idea. Paper strength was investigated under ultra high vacuum at room temperature [69]. Using this approach the authors attempted to proof the existence of capillary bridges by changes in the paper strength between high- and ultrahigh vacuum. However the results were inconclusive.

## 4 Fiber Bond Failure

The failure of materials under load occurs in three different modes, figure 8. Cracks may propagate in the plane perpendicular to normal stress (mode 1, peeling), in the plane with shear stresses with the crack line perpendicular to the

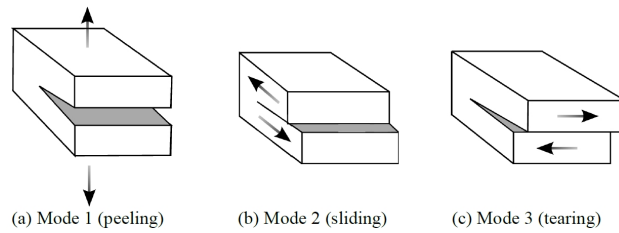

**Figure 8** The three modes of failure in fracture mechanics.

stresses (mode 2, sliding) or in the plane with shear stress with the crack line parallel to the shear stress (mode 3, tearing). Depending on the loading situation and the material, failure may occur due to normal- or shear stresses. In order to understand the failure of fiber-fiber joints we thus need to analyze the stresses in the bonding region.

A fiber-fiber joint in the configuration as a lap joint is shown in figure 9 (left). The stress distribution in such a type of joint gives figure 9 (right). One can see that the stresses in the center of the joint are low and that the peak stresses are occurring at the edge of the bond. Button [71] has extensively studied the failure of lap joints. Due to the high peak stresses occurring at the edge of the joint, the failure starts at the edge and moves inwards [71, 72, 73]. The failure of the joint is thus governed by the *peak stress* at the edges of the joint. As a consequence the length  $L$  of a lap joint has only a minor influence on its strength, its thickness  $t$  and the E-modulus  $E$  of the material instead have a large influence [71], compare figure 9 (left). This basic idea also holds for all other configurations and loading situations of individual fiber-fiber joints, the failure is always driven by the peak stresses at the edges of the bond.

Progressive failure from the edges to the center of the bond has been observed in fiber-fiber joint testing, where sudden drops in loading force indicate local failure of the bond [72, 74, 62]. There is considerable evidence that failure in paper also occurs due to progressive failure of fiber-fiber bonds. Nordman et al. [75] observed that the light scattering coefficient of paper increases upon straining. The increase in light scattering can be attributed to new surface area created in the paper due to the separation of previously bonded fiber regions [73]. Investigations of fiber-fiber bonds in paper using polarized light microscopy have shown that the bonds indeed fail progressively under dynamic load [76] as well as under constant load, i.e. creep testing [77]. Further direct evidence for progressive failure for fiber-fiber bonds was found in the AFM based mode 1 breaking of fiber fiber joints [62]. It revealed sequential failure of the joint with distinctive, sudden drops in the debonding force of refined fibers, whereas no such force discontinuities have been found for unrefined fibers [62]. The sudden force drops can be interpreted as the failure of individual, fibrils, fibril bundles and parts of the S1



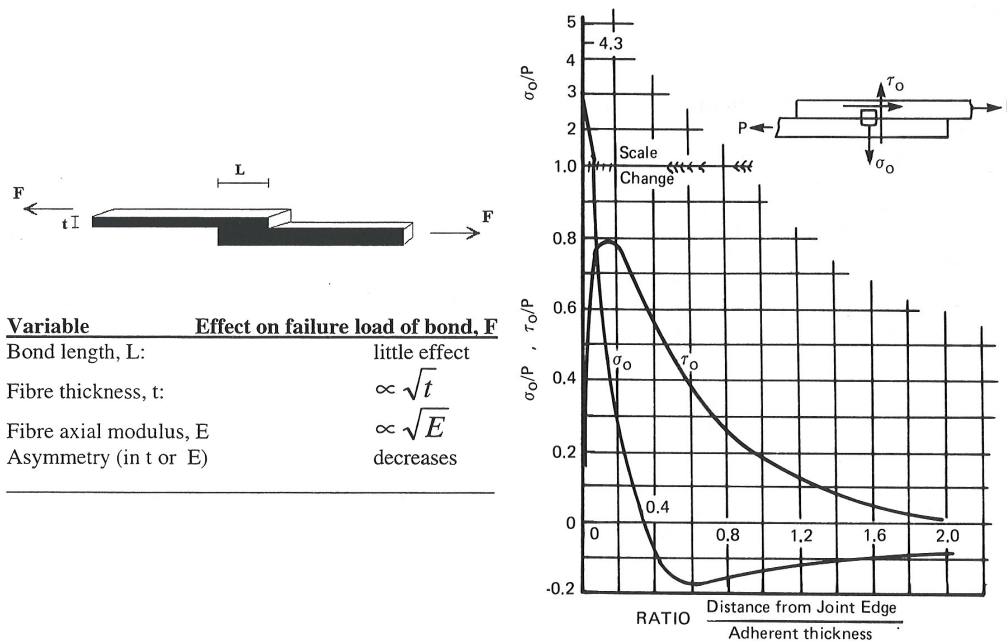

**Figure 9** Idealized configuration of a fiber-fiber bond as a lap joint (left) [70, 71]. The stress distribution in a lap joint (right) [72].  $\tau_0$  is the shear stress,  $\sigma_0$  is the normal stress and P is the mean tensile stress in the joined pieces.

fiber wall breaking away.

In general the increase of fiber wall damage increases with the strength of the fiber-fiber bond. Stratton and Colson [61] have investigated the amount of fibre wall damage for single fiber-fiber joints of differently treated pulps. The joint strength of fibers treated with a dry strength agent showed significantly higher breaking strength and exhibited fibrils and larger parts torn off the fiber wall, very similar to the refined fibers shown in figure 7. They concluded that, independent of the mechanism of strength increase, weak bonds are failing at the interface between the bonded fibers, whereas for strong bonds the locus of failure shifts to the region between S1 and S2 which leads to tearing out of material from the surface.

In the literature the strength of fiber-fiber bonds is often described to be the product of the bonded area and the so called *specific bond strength* [78] given in  $N/mm^2$ . The specific bond strength is employed as the parameter describing the strength of the bonding per unit area. However, the assumption that the strength of a fiber-fiber joint increases linearly with the bonded area can neither be observed in single fiber joint testing experiments [79, 80], nor by simulations [81]. The concept of specific bond strength is assuming evenly distributed load carrying in the bonded area, which is not the case. The material property determining the

resistance to the progressing growth of a crack in the failing fiber-fiber joint is the fracture toughness [71]. The fracture toughness is defined as the amount of energy required to generate the new surface created by the growth of a crack. It is related to the bonding energy per bonded area as discussed in the previous sections.

We thus conclude that the concept of specific bond strength is not suitable to understand the failure process of fiber-fiber joints. That is the reason why measuring the bond strength of individual fibers and comparing the results to the specific bond strength obtained via the Page equation does not work. Weber et al. [79] measured the specific bond strength via determining the optically bonded area using polarization microscopy [82] and the bonding force necessary to open individual fiber-fiber joints, from these values they calculated the specific bond strength. Simultaneously they determined the specific bond strength using the Page equation [78]. It was found that the values did not match [79]. Instead of specific bond strength the failure process of fiber-fiber joints is driven by two factors. The first factor is the peak stress in the joint which initiates the failure, it depends on the load and the geometrical configuration of the joint. The other factor is the fracture toughness of the bond, which is the energy required to create the crack surface [71] it is equivalent to the bonding energy in the bonded surface.

The dependance of fiber-fiber joint failure on the peak stresses in the bonding region has profound implications on all types of single fiber-fiber joint strength testing methods [83, 84, 29, 28, 74, 85]. The strength of the joint is not only determined by the bonding area itself, but it also largely influences by the shape of the fiber cross section, the configuration of the fibers and the load application [72]. In fact large differences in fiber-fiber joint strength for the same softwood pulp were found for different loading modes, predominantly mode 1 [28, 62], as well as predominantly mode 2 and mode 3 measurements [29]. The necessity to understand the actual load and the stresses in the fiber-fiber bonding region has led to a combined approach of physical testing of fiber-fiber joint strength and FEM modeling of the experiment [81, 86, 87]. Using this combined approach the resultant forces and moments [86, 87] in the bonding region can be calculated and the peak stresses [87] can be estimated. This type of analysis can be used to analyze the failure mechanism of fiber fiber bonds. The results of two of these studies [87, 88] both indicate that mode 1 failure (i.e. normal load) might be relevant for fiber-fiber joints. This is in sharp contrast to the common believe that shear forces are the main source of failure in fiber-fiber bonds.

## 5 CONCLUSIONS AND FUTURE CHALLENGES

The area in molecular contact between the fiber surfaces is the most important parameter for fiber-fiber bonding as it provides the surface where the individual

molecular bonding mechanisms then can take place. Measuring it in actual pulp fiber-fiber bonds and quantifying its contribution for the overall bonding will be one of the most important challenges that need to be solved in order to obtain a quantitative understanding of fiber-fiber bonding. Interdiffusion essentially also increases the area in molecular contact, it is yet unclear how large its contribution to fiber-fiber bonding is. From an experimental point of view nanoscale measurements of fiber surface mechanics (hardness, viscoelasticity, surface topography) need to be conducted for different kinds of pulp, also in the presence of wet end strength additives. This should lead to a better understanding of the bonding mechanisms of different pulp types and wet end chemicals.

Regarding the molecular bonding mechanisms it seems that both, Van der Waals forces as well as hydrogen bonding are playing a relevant role in fiber-fiber bonding. There is no conclusive evidence yet that one or the other is prevalent. Coulomb interactions definitely contribute directly to fiber-fiber bonding, carboxylic groups on and in the fiber additionally promote swelling and thus the molecular contact area.

The two non-molecular bonding mechanisms are mechanical interlocking and capillary bridges. It has been shown conclusively that mechanical interlocking of the fibrils on the fiber surface, which are e.g. created by refining, indeed contributes to fiber-fiber bonding. The existence of capillary bridges in dry paper is quite likely, however experimental results indicating a contribution to fiber-fiber bonding have not yet been worked out.

Finally, it will be very important to gain a deeper insight into the failure mechanisms in fiber-fiber bonds. Determination of the actual fracture toughness of different types of fiber-fiber bonds is a highly interesting, yet challenging research goal.

In terms of advancing fiber-fiber bonding the mechanism with probably the highest potential for significant improvements is Coulomb interaction, as it is a strong and far reaching interaction and the concentration of carboxylic groups on the natural fiber surfaces is limited. Clarification of the actual molecular contact area in fiber-fiber bonds will reveal if there is also potential for improvements. If the degree of molecular contact between fibers is low that would be a large and promising potential for strength improvements, if it turns out to be close to 100% further research there is not necessary. All other mechanisms can hardly be improved. They either depend on the number of available species (hydrogen bonds) or on the total number of atoms (Van der Waals bonds) within the area in molecular contact. Capillary bridges can only occur when there is no molecular contact between the surfaces - it is only an improvement if molecular bonding is not taking place. Considering mechanical interlocking an ideal fiber treatment would promote external fibrillation without shortening the fibers or reducing their strength.

Right now we are only at the beginning of understanding quantitatively how fiber-fiber bonding is actually working. Many key questions are still unresolved. It remains puzzling that something as simple as making a sheet of paper, which people have been doing for more than two thousand years now, turns out to involve three molecular adhesion mechanisms, contact mechanics and fluidics on the nanoscale and gel-phase swelling / diffusion.

## 6 ACKNOWLEDGEMENTS

The financial support of the Austrian Federal Ministry of Economy, Family and Youth and the National Foundation for Research, Technology and Development is gratefully acknowledged.

## REFERENCES

- [1] T. Lindström, L. Wagberg, and T. Larsson. On the nature of joint strength in paper a review of dry and wet strength resins used in paper manufacturing. *Trans. 13th Fund. Res. Symp. Cambridge*, pages 457–562, 2005.
- [2] M. Hubbe. Bonding between cellulosic fibers in the absence and presence of dry-strength agents a review. *BioResources*, 1(2):281–318, 2006.
- [3] K. Niskanen, editor. *Paper Physics*. Paperi ja Puu Oy, 2008.
- [4] Ezequiel Delgado-Fornué, Héctor J Contreras, Guillermo Toriz, and G Graham Allan. Adhesion between cellulosic fibers in paper. *Journal of Adhesion Science and Technology*, 25(6-7):597–614, 2011.
- [5] U. Hirn and R. Schennach. Comprehensive analysis of individual pulp fiber bonds quantifies the mechanisms of fiber bonding in paper. *Scientific Reports*, 5:10503, 1–9, 2015.
- [6] U. Hirn, R. Schennach, C. Ganser, M. Magnusson, C. Teichert, and S. Östlund. The area in molecular contact in fiber-fiber bonds. In *Trans. of the 15th Fundamental Research Symposium, Cambridge*, pages 201–226, 2013.
- [7] C. Yang and B N J Persson. Contact mechanics: Contact area and interfacial separation from small contact to full contact. *J. Phys.: Condens. Matter*, **20**:215214 (13pp), 2008. doi:10.1088/0953-8984/20/21/215214.
- [8] B. N. J. Persson. *Sliding Friction*. Springer, 1997. ISBN 3-540-63296-4.
- [9] B N J Persson, O Albohr, U Tartaglino, A I Volokitin, and E Tosatti. On the nature of surface roughness with application to contact mechanics, sealing, rubber friction and adhesion. *Journal of Physics: Condensed Matter*, 17(1):R1–R62, dec 2004.

- [10] B.N.J. Persson. Theory of rubber friction and contact mechanics. *Journal of Chemical Physics*, 115(8):3840–3861, 2001.
- [11] B.N.J. Persson. Contact mechanics for randomly rough surfaces. *Surface Science Reports*, 61(4):201–227, jun 2006.
- [12] A. Almqvist, C. Campañá, N. Prodanov, and B.N.J. Persson. Interfacial separation between elastic solids with randomly rough surfaces: Comparison between theory and numerical techniques. *Journal of the Mechanics and Physics of Solids*, 59(11):2355–2369, nov 2011.
- [13] L. Wågberg and G. Annergren. Physicochemical characterization of papermaking fibres. In C.F. Baker, editor, *The Fundamentals of Papermaking, Trans. 11th Fund. Res. Symp. Cambridge*, pages 1–82, 1997. ISBN: 0 9545272 1 6.
- [14] T. G. M. van de Ven. Capillary forces in wet paper. *Ind. Eng. Chem. Res.*, **47**:7250–7256, 2008. DOI: [10.1021/ie800423r](https://doi.org/10.1021/ie800423r).
- [15] D. Yan and K. Li. Real contact area between fibers surfaces. In *Trans. of the 15th Fundamental Research Symposium, Cambridge*, pages 143–173, 2013.
- [16] D. Page. Fibre-to-fibre bonds - part 1. a method for their direct observation. *Paper Technology*, **4**:407, 1960.
- [17] L. Kappel, U. Hirn, E. Gilli, W. Bauer, and R. Schennach. Revisiting polarized light microscopy for fiber-fiber bond area measurement - part ii: Proving the applicability. *Nordic pulp & paper research journal*, **25**:71, 2010.
- [18] E. Gilli, L. Kappel, U. Hirn, and R. Schennach. An optical model for polarization microscopy analysis of pulp fibre to fibre bonds. *Composite Interfaces*, **16**(7-9):901–922, 2009.
- [19] L. Kappel, U. Hirn, W. Bauer, and R. Schenach. A novel method for the determination of bonded area of individual fiber-fiber bonds. *Nordic pulp & paper research journal*, **24**(2):199 – 205, 2009.
- [20] C. Marulier, P.J.J. Dumont, L. Orgas, D. Caillerie, and S. Rolland du Roscoat. Towards 3d analysis of pulp fibre networks at the fibre and bond levels. *Nordic pulp & paper research journal*, **27**:245–255, 2012.
- [21] E. Retulainen, J. Parkkonen, and A. Miettinen. X-ray nanotomography of fiber bonds. In *Progress in Paper Physics Seminar 2016 Darmstadt*, pages 162–168, 2016.
- [22] S. Asunmaa and B. Steenberg. Beaten pulps and the fibre-to-fibre bond in paper. *Svensk Papperstidning*, **61**(18b):686, 1958.

- [23] C. Thomson, R. Lowe, and A. Ragauskas. Imaging cellulose fibre interfaces with fluorescence microscopy and resonance energy transfer. *Carbohydrate Polym.*, **69**:799–804, 2007.
- [24] C. Thomson, R. Lowe, D. Page, and A. Ragauskas. Exploring fibre-fibre interfaces via fret and fluorescence microscopy. *J. Pulp and Paper Sc.*, **34**:113–120, 2008.
- [25] B. N. J. Persson, C. Ganser, F. Schmied, C. Teichert, R. Schennach, E. Gilli, and U. Hirn. Adhesion of cellulose fibers in paper. *J. of Physics: Condensed Matter*, **25**:045002 – 11 pages, 2013. doi:10.1088/0953-8984/25/4/045002.
- [26] Christian Ganser, Ulrich Hirn, Sebastian Rohm, Robert Schennach, and Christian Teichert. AFM nanoindentation of pulp fibers and thin cellulose films at varying relative humidity. *Holzforschung*, 68(1):53–60, 2014. doi:10.1515/hf-2013-0014.
- [27] L. Kappel. *Development and Application of a Method for Fiber-Fiber Bonded Area Measurement*. PhD thesis, Graz University of Technology, 2010.
- [28] F. Schmied, C. Teichert, L. Kappel, U. Hirn, and R. Schennach. Joint strength measurements of individual fiber-fiber bonds – an atomic force microscopy based method. *Review of scientific instruments*, 83:073902–1 – 073902–8, 2012. http://dx.doi.org/10.1063/1.4731010.
- [29] W. Fischer, U. Hirn, R. Schennach, and W. Bauer. Testing of individual fiber-fiber joints under biaxial load and simultaneous analysis of deformation. *Nordic Pulp & Paper Research Journal*, 27:237–244, 2012.
- [30] R. Pelton. A model of the external surface of wood pulp fibers. *Nord. Pulp Pap. Res. J.*, 8(1):113–119, 1993.
- [31] T. Krause and W. Schrempp. Verfahrenstechnische Grundlagen der Blattbildung (in German). *Wochenblatt der Papierfabrikation*, 106(1):21–27, 1978.
- [32] A. McKenzie. The structure and properties of paper part xxi: The diffusion theory of adhesion applied to interfibre bonding. *Appita J.*, 37(7):580–583, 1984.
- [33] N. Nordgren, H. Lönnberg, A. Hult, E. Malmström, and M. Rutland. Adhesion dynamics for cellulose nanocomposites. *ACS Applied Materials & Interfaces*, 1(10):2098–2103, 2009.
- [34] A. M. Scallan and J. Grignon. The effect of cations on pulp and paper properties. *Svensk Papperstidning*, 82(2):40–47, 1979.
- [35] M. Adam and M. Delsanti. Dynamical properties of polymer solutions in good solvent by Rayleigh scattering experiments. *Macromolecules*, 10(6):1229–1237, 1977.
- [36] J. Feng, H. Pham, V. Stoeva, and M.A. Winnik. Polymer diffusion in latex films at ambient temperature. *J Polymer Sci B: Polymer Physics*, 36:1129–1139, 1998.

- [37] A. Jonas, A. C. De Luca, G. Pesce, G. Rusciano, A. Sasso, S. Caserta, S. Guido, and G. Marrucci. Diffusive mixing of polymers investigated by raman microspectroscopy and microrheology. *Langmuir*, 26(17):14223–14230, 2010. PMID: 20681558.
- [38] D. Stadelmaier and W. Köhler. Thermal diffusion of dilute polymer solutions: The role of chain flexibility and the effective segment size. *Macromolecules*, 42(22):9147–9152, 2009.
- [39] C. Thomson, R. Lowe, and A. Ragauskas. First characterization of the development of bleached kraft softwood pulp fiber interfaces during drying and rewetting using fret microscopy. *Holzforschung*, 62:383–388, 2008.
- [40] A.H. Nissan. General principles of adhesion with particular reference to the hydrogen bond. In F. Bolam, editor, *Trans. 2nd Fund. Res. Symp. Oxford, 1961*, pages 119–130, 1961.
- [41] Y.M. Haddad. A theoretical approach to interfiber bonding of cellulose. *J. Coll. Interf. Sci.*, 1980(2):480, 77.
- [42] Wolfgang G. Glasser, Rajai H. Atalla, John Blackwell, R. Malcolm Brown, Walther Burchard, Alfred D. French, Dieter O. Klemm, and Yoshiharu Nishiyama. About the structure of cellulose: debating the lindman hypothesis. *Cellulose*, 19(3):589–598, mar 2012.
- [43] Alfred D. French, Monica Concha, Michael K. Dowd, and Edwin D. Stevens. Electron (charge) density studies of cellulose models. *Cellulose*, 21(2):1051–1063, sep 2014.
- [44] R. Parthasarathi, G. Bellesia, S. P. S. Chundawat, B. E. Dale, P. Langan, and S. Gnanakaran. Insights into hydrogen bonding and stacking interactions in cellulose. *The Journal of Physical Chemistry A*, 115(49):14191–14202, dec 2011.
- [45] P. Przybysz, M. Dubowik, M.A. Kucner, K. Przybysz, and K. Przybysz Buzala. Contribution of hydrogen bonds to paper strength properties. *PLoS ONE*, 11(5):e0155809, 2016. <https://doi.org/10.1371/journal.pone.0155809>.
- [46] R. Pelton. On the design of polymers for increased paper dry strength a review. *Appita J.*, 57(3):181–190, 2004.
- [47] Jin Zhang, Robert Pelton, Lars Wågberg, and Mats Rundlöf. The effect of charge density and hydrophobic modification on dextran-based paper strength enhancing polymers. In *Nordic Pulp & Paper Research Journal*, volume 15, pages 440–445, 2000.
- [48] Pedram Fatehi, Kevin C Outhouse, Huining Xiao, and Yonghao Ni. Debonding performance of various cationic surfactants on networks made of bleached kraft fibers. *Industrial & Engineering Chemistry Research*, 49(22):11402–11407, 2010.

- [49] F. Weber, G. Koller, R. Schennach, I. Bernt, and R. Eckhart. The surface charge of regenerated cellulose fibres. *Cellulose*, 20:2719–2729, 2013.
- [50] S. Rohm, U. Hirn, C. Ganser, C. Teichert, and R. Schennach. Thin cellulose films as a model system for paper fibre bonds. *Cellulose*, 21(1):237–249, nov 2014. <http://dx.doi.org/DOI 10.1007/s10570-013-0098-x>.
- [51] A. Torgnysdotter and L. Wagberg. Influence of electrostatic interactions on fiber-fiber joint and paper strength. *Nord. Pulp Pap. Res. J.*, 19(4):440–447, 2004.
- [52] J Laine, T Lindstrom, G Glad Nordmark, and G Risinger. Studies on topochemical modification of cellulosic fibres. part 2. the effect of carboxymethyl cellulose attachment on fibre swelling and paper strength. *Nordic Pulp & Paper Research Journal*, 17(1):50–56, 2002.
- [53] D. Barzyk, D. Page, and A. Ragauskas. Acidic group topochemistry and fibre-to-fibre specific bond strength. *J. Pulp Paper Sc.*, 23(2):J59–J61, 1997.
- [54] J. Sjöberg, M. Kleen, O. Dahlman, R. Agnemo, and H. Sundvall. Analyses of carbohydrates and lignin in the surface and inner layers of softwood pulp fibers obtained employing various alkaline cooking processes. *Nordic Pulp & Paper Research Journal*, 17(3):295–301, 2002.
- [55] Pedro Fardim and Bjarne Holmbom. Origin and surface distribution of anionic groups in different papermaking fibres. *Colloids and Surfaces A: Physicochemical and Engineering Aspects*, 252(2):237–242, 2005.
- [56] J. Grignon and A. M. Scallan. Effect of pH and neutral salts upon the swelling of cellulose gels. *J. Appl. Polym. Sci.*, 25(12):2829–2843, 1980.
- [57] T. Kang, H. Paulapuro, and E. Hiltunen. Fracture mechanism in interfibre bond failure - microscopic observations. *Appita J.*, 57(3):199–203, 2004.
- [58] P. Saketi. *Microrobotic platform with integrated force sensing microgrippers for characterization of fibrous materials: Case study on individual paper fibers*. PhD thesis, Tampere University of Technology, 2015.
- [59] M. Jajcinovic. *Strength of individual fibres and fibre to fibre joints - influence of pulp type, relative humidity and the degree of refining*. PhD thesis, Graz University of Technology, 2017.
- [60] C. Mayhood, O. Kallmes, and M Cauley. The mechanical properties of paper. part ii: Measures shear strength of individual fiber-fiber bonds. *Svensk Papperstidning*, 45(1):69–73, 1962.
- [61] R. A. Stratton and N. L. Colson. Fiber wall damage during bond failure. *Nord. Pulp Pap. Res. J.*, 8:245–257, 1993.



- [62] F. Schmied, C. Teichert, L. Kappel, U. Hirn, W. Bauer, and R. Schennach. What holds paper together: Nanometre scale exploration of bonding between paper fibres. *Scientific Reports*, 3:2432 1–6, 2013. <http://dx.doi.org/10.1038/srep02432>.
- [63] D. H. Page and P. A. Tydeman. A new theory of the shrinkage, structure and properties of paper. In *Fund. Res. Symp 1961, The formation and structure of paper, vol. 1*, pages 397–425, 1962.
- [64] W. J. Fischer, A. Zankel, C. Ganser, F. J. Schmied, H. Schroettner, U. Hirn, C. Teichert, W. Bauer, and R. Schennach. Imaging of the formerly bonded area of individual fibre to fibre joints with SEM and AFM. *Cellulose*, 21(1):251–260, 2014. [10.1007/s10570-013-0107-0](https://doi.org/10.1007/s10570-013-0107-0).
- [65] Hailong Liu and Guoxin Cao. Effectiveness of the young-laplace equation at nanoscale. *Scientific reports*, 6:23936, 2016.
- [66] B N J Persson. Capillary adhesion between elastic solids with randomly rough surfaces. *J. Phys.: Condens. Matter*, 20:315007(11p), 2008. [doi:10.1088/0953-8984/20/31/315007](https://doi.org/10.1088/0953-8984/20/31/315007).
- [67] W Ranke and YR Xing. Orientation dependent adsorption on a cylindrical silicon crystal: I. water. *Surface science*, 157(2-3):339–352, 1985.
- [68] Paul Aveling Redhead, John Peter Hobson, and Ernest Victor Kornelsen. *Physical basis of ultrahigh vacuum*. Chapman and Hall LTD, London, 1968.
- [69] R. Schennach, M. Kornschöber, and U. Hirn. Do capillary bridges play a role in dry paper? In *Fundamental Research Communications*, pages 17–21, 2013.
- [70] E. Retulainen. *The Role of Fibre Bonding in Paper Properties*. PhD thesis, Helsinki University of Technology, 1997.
- [71] A. F. Button. *Fiber-fiber bond strength: A study on the linear elastic model structure*. PhD thesis, Institute of Paper Chemistry, Appleton, Wisconsin, 1979.
- [72] T. Uesaka. *Handbook of Physical and Mechanical Testing of Paper and Paperboard (Vol.2)*, chapter Determination of fiber-fiber bond properties, pages 379–402. Marcel Dekker Inc. New York, 1984.
- [73] D. H. Page. The meaning of nordman bond strength. *Nord. Pulp Pap. Res. J.*, 17(1):39–44, 2002. DOI: 10.3183/NPPRJ-2002-17-01-p039-044.
- [74] M. Magnusson, X. Zhang, and S. Östlund. Experimental evaluation of the interfibre joint strength of papermaking fibres in terms of manufacturing parameters and in two different loading directions. *Experimental Mechanics*, 2013. DOI 10.1007/s11340-013-9757-y.

- [75] L. Nordmann, C. Gustafsson, and G. Olofsson. On the strength of bondings in paper. *Paperi ja Puu*, **3**:47, 1952.
- [76] D. H. Page, P. A. Tydeman, and M. Hunt. A study of fibre-to-fibre bonding by direct observation. In *Fund. Res. Symp 1961, The formation and structure of paper, vol. 1*, pages 171–194, 1962.
- [77] A. DeMaio, R. Lowe, T. Patterson, and A. Ragauskas. Direct observations of bonding influence on the tensile creep behavior of paper. *Nordic pulp & paper research journal*, **21**(3):297–302, 2006.
- [78] D.H. Page. A theory for the tensile strength of paper. *Tappi J.*, **52**(4):674–681, 1969.
- [79] Frederik Weber, Christian Ganser, Christian Teichert, Robert Schennach, Ingo Bernt, and Rene Eckhart. Application of the page-equation on flat shaped viscose fibre handsheets. *Cellulose*, **21**(5):3715–3724, aug 2014.
- [80] Marina Jajcinovic, Wolfgang J Fischer, Ulrich Hirn, and Wolfgang Bauer. Strength of individual hardwood fibres and fibre to fibre joints. *Cellulose*, **23**(3):2049–2060, 2016.
- [81] Annsofie Torgnydotter, Artem Kulachenko, Per Gradin, and Lars Wågberg. Fiber/fiber crosses: finite element modeling and comparison with experiment. *Journal of composite materials*, **41**(13):1603–1618, 2007.
- [82] L. Kappel, U. Hirn, E. Gilli, W. Bauer, and R. Schennach. Revisiting polarized light microscopy for fiber-fiber bond area measurement - part 1: Theoretical fundamentals. *Nordic Pulp & Paper Research Journal*, **25**(1):65–70, 2010.
- [83] A. P. Schniewind, L. J. Nemeth, and D. L. Brink. Fiber and Pulp Properties - I. Shear Strength of single Fiber Crossings. *Tappi J.*, **47**:244–248, 1964.
- [84] R. A. Stratton and N. L. Colson. Dependence of Fiber/Fiber Bonding on some Papermaking Variables. Technical Report IPST Technical Paper Series. Number 357, Institute of Paper Science and Technology Atlanta, Georgia, 1990.
- [85] Pooya Saketi, Seyed Kourosch Latifi, Juha Hirvonen, Satu Rajala, Antti Vehkaoja, Timo Salpavaara, Jukka Leikkala, and Pasi Kallio. PVDF microforce sensor for the measurement of z-directional strength in paper fiber bonds. *Sensors and Actuators A: Physical*, **222**:194–203, feb 2015.
- [86] M. S. Magnusson and S. Östlund. Numerical evaluation of interfibre joint strength measurements in terms of three-dimensional resultant forces and moments. *Cellulose*, 2013. doi:10.1007/s10570-013-9939-x.
- [87] T. Ebner, U. Hirn, W. Fischer, F. Schmied, R. Schennach, and M. Ulz. A proposed failure mechanism for pulp fiber-fiber joints. *Bioresources*, **11**(4):9596–9610, 2016.

- [88] Mikael S. Magnusson. Investigation of interfibre joint failure and how to tailor their properties for paper strength. *Nordic Pulp & Paper Research Journal*, 31(1):109–122, 2016.