

# Evaluation of Novel Safety Concepts for Automotive Perception in Real-World Environments

Philipp Stelzer  
Graz University of Technology  
Graz, Austria  
stelzer@tugraz.at

Andreas Strasser  
Graz University of Technology  
Graz, Austria  
strasser@tugraz.at

Josef Steinbaeck  
Graz University of Technology  
Graz, Austria  
steinbaeck@tugraz.at

Christian Steger  
Graz University of Technology  
Graz, Austria  
steger@tugraz.at

Markus Schratzer  
Virtual Vehicle Research Center  
Graz, Austria  
markus.schratzer@v2c2.at

Norbert Druml  
Infineon Technologies Austria AG  
Graz, Austria  
norbert.druml@infineon.com

**Abstract**—Safety is one of the most important topics regarding Automated-Driving in the Automotive Domain. In the last years, LiDAR, Radar and Vision Cameras became the most relevant Environmental Perception Sensors for enabling safe and robust Automated-Driving. All of these systems offers specific strengths and weaknesses in specific situations such as bright sunlight or heavy rain. Therefore, these systems requires specific Fail-Operational concepts to allow robust and safe driving in urban and rural environments.

In this publication, we are depicting Real-World evaluation of Safety Concepts and Fail-Operational functionality of a Sensor Fusion Platform that offers Radar, 3D Flash LiDAR and Vision Cameras. We verified our platform in specific driving situations such as driving from an urban parking environment into bright sunlight with the dynamic adaption of the confidence range that depicts reliable data.

**Index Terms**—Safety, Fail-Operational Concepts, Automotive, Reliability

## I. INTRODUCTION

Automated Driving is one of the most challenging tasks in the Automotive Domain nowadays. The reason is the transition from fail-safe to fail-operational behavior including the absence of the driver as the last safety instance. Automated

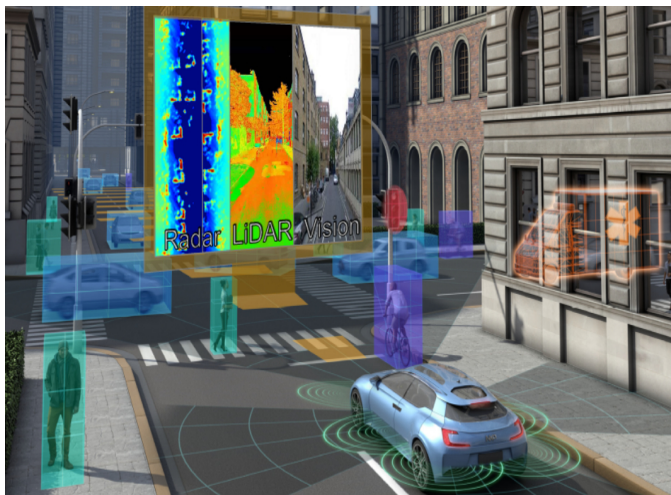

Fig. 1. PRYSTINE's concept view of a fail-operational urban surround perception system [1].

Driving enforces the overall Automotive system to acquire the human senses that are needed for driving a car such as vision to enable a safe driving experience. The visual sense is provided by specific environmental perception sensors such as Light Detection and Ranging (LiDAR), Radio Detection and Ranging (RADAR) or Vision Cameras. Based on these three systems, a robust and fail-operational system can be provided to enable a safe and robust Automated Driving such as the FUSION system of the PRYSTINE project [1]. Safe and robust driving is one of the key factors for a high acceptance and trust of semi- and automated driving functionalities on public roads [2]. Therefore, novel concepts needs to be developed and considered because the traditional thinking of safety according the ISO 26262 standard does not fulfill these high standards yet. The ISO 26262 standard declares that a safety mechanism is responsible for the transition of the overall system into a safe state but in case of unexpected behavior the system is able to forward this responsibility to the driver as last safety instance [3]. In the past, there already happened accidents with automated driving functionalities [4]. It is even questionable if future autonomous vehicles will be ever able to prevent all accidents at all. But they can be one of the key enablers for reducing accidents that are mostly based on human failures such as driving with high speed or long reaction times. Therefore, the overall effort of advancing the current Advanced Driving Assistance Systems (ADAS) is worth to continue and this publication is contributing to the current scientific work with a focus on the current Automotive Industry.

## II. RELATED WORK

To test novel safety concepts in real-world environments under realistic weather conditions it requires a working sensor fusion platform that provides different sensors such as Radar, 3D Flash LiDAR and Vision cameras. For this publication, we were able to advance an existing Sensor Fusion platform that was already used for different Automotive scenarios such as Parking Assistance systems and other Context-Aware scenarios [5]–[8]. The overall safety of Automated Driving systems inside vehicles is strongly connected to a

high acceptance of the drivers that will be transformed to passengers inside these cars [2]. Nowadays, the current ISO 26262 standard [3] represents the de facto standard for safety in the Automotive domain. This standard describes basic methods for handling complexity and enabling a safe and robust functionality such as redundant systems. Basically, a Fault is able to trigger a Failure inside a Component and this could be propagated to an Item that will switch to a Failure mode. This scenario clearly shows the interlock between single faults that can trigger a total failure of the whole system. To prevent such failures, the Automotive Industry but also other Industries are using redundancy on System Level as well as have a strong focus on reliability [9].

Emmerich et al. introduced a Systems Engineering Framework and Application to an Open Automated Driving Platform [10]. In their research work, they have developed an Automated Driving demonstrator that is based on overall business needs with a top-down approach from the requirements engineering to the implementation. Their focus was on developing a framework and methodology with a focus on cost reduction and technical flexibility [10].

Kokogias et al. introduced a novel platform-independent system for cooperative Automated Driving. Their approach clearly shows that collaborative automated driving is feasible and that the system are able to communicate to each other with a specific standard protocol. They emphasizes that the biggest challenge was the ongoing testing and the participation of individual teams. Their Real-World testing was successful and highlights the feasibility of their approach [11].

The verification of Automated Driving functionalities is one of the most important topics. Developing a real system requires high effort as well as always has the possibility of wrong or missing requirements. But there is also the need of a quick verification of novel ideas and concepts. To handle this situation as well as to enable shorter development cycles simulations can be used such as the Scenario Simulation Platform. Pilz et al. [12] developed a simulation-based automated driving verification system. Their approach is based on existing simulators but also extending them with multiplayer game engines. Their system enables engineers to test Automated Driving algorithms inside the virtual environments and to control a vehicle [12].

In general, Sensor Fusion platforms in the context of Automated Driving are necessary for evaluating different scenarios but also there are many blind spots regarding the different communication layers. Bijlsma et al. [13] introduced a novel Multi-Sensor Fusion Platform to support the verification of mixed-criticality algorithms in the context of Automated Driving. Their iVSP platform represents a layer-based fusion platform consisting different sensors and can be divided in a Sensor, Communication, Actuation, Information and Application Layer. The results clearly show that their framework can be used for designing and implementing safety-critical ADAS algorithms for prototype purpose [13].

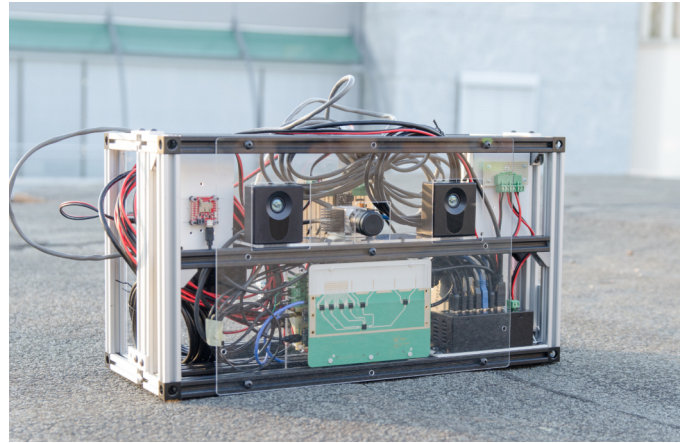

Fig. 2. Sensor Fusion Platform that was used for the further experiments of the use cases.

Therefore, this publication’s contribution to existing research is:

- Developing novel methods and concepts for Automotive Perception sensors to handle safety issues such as sensor failure or environmental caused data interferences.
- Implementing these novel concepts inside a Sensor Fusion prototype platform that provides Vision Camera, Radar and 3D Flash LiDAR.
- Testing the novel concepts in Real-World environments.

### III. PROTOTYPE PLATFORM AND USE CASES

#### A. Sensor Fusion Platform

An existing environmental perception platform is extended in order to evaluate and demonstrate newly developed methods and techniques to improve the functional safety of road vehicles. The existing platform consists of multiple ToF sensors, a vision camera and a radar sensor. Additionally, the platform is capable to obtain simultaneous measurements from the different sensors via a common trigger signal, generated by a microcontroller. A processing unit is included in the platform, which oversees processing the measurement data (data-handling, pre-processing, fusion). A lithium battery allows to utilize the platform in mobile mode. The platform is built within an aluminum profile cage, which allows easy mounting of the platform on mobile robots or vehicles. A picture of the environmental perception platform can be seen in Figure 2.

#### B. Use Cases Overview

Functional Safety is one of the most important key factors for novel automated driving vehicles. Automated driving forces engineers to perform a transition of fail-safe to fail-operational behavior. The current prototype platform considers this change of thinking and already has implemented fail-operational behavior and is able to demonstrate these properties with four different Use Cases:

### 1) Context Dependent Field-of-View

The vehicle adapts the sensors FoV depending on its current environment.

### 2) Field-of-View Adaption in Case of Sensor Failure

The platform detects a faulty sensor and re-configures the remaining sensors in order to compensate the lost sensor coverage.

### 3) Context-Aware Sensor Degradation

The platform detects a context states affecting the performance of its perception sensors. A confidence range is then assigned to the sensors data streams.

### 4) Resolution Reduction

The system can react to a high memory utilization with a reduction of the sensors output resolution. This protects the memory in long term application.

## C. Context Dependent Field-of-View

The implemented use case shall show the following safety-features: When the vehicle drives with high-speed on a highway, the sensor setups FoV shall be narrow and provide high spatial-resolution. This enables the detection of vehicles/objects at a higher range. When the vehicle is operated at a low speed in an urban area, the perception system shall change to a wide-angle and lower spatial resolution. A conceptual overview of the Use Case can be seen in Figure 3.

In order to adapt the field-of-view the parameter-adaption module has to be aware of the contextual information. In the case of a context dependent field-of-view, the information about the current context area (urban area, highway) is assumed to be available from an external map/localization module. Thus, the module takes as input an identifier, which provides the module an identifier about the current context.

## D. Field-of-View Adaption in Case of Sensor Failure

The FoV for the remaining sensors is adapted in order to compensate the failure of a single sensor as seen in Figure 4. However, in order to provide the same frame-rate, the resolution of the remaining sensors is reduced.

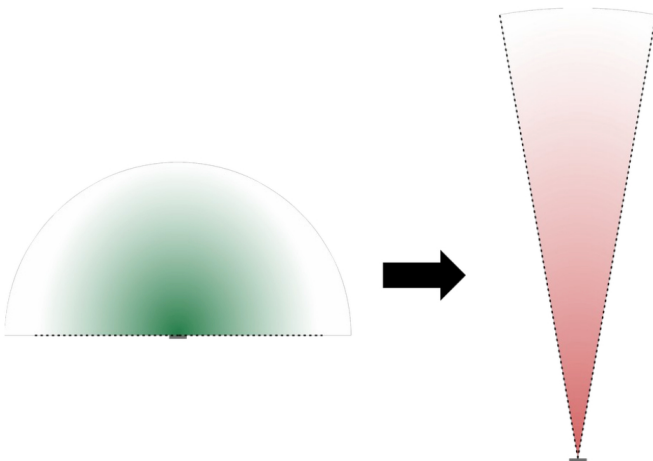

Fig. 3. Concept overview of the Context Dependent Field-of-View use case.

cause of sensor failure is high mechanical stress to the sensor. E.g., when the vehicle drives through a pothole or hits an object.

In order to change the FoV in order of a sensor failure, the parameter-adaption module has to be aware of the sensor failure. If a sensor failure is given, the parameter adaption module changes the perception sensors parameters in order to change their FoV. The sensor failure is detected using diagnosis functionality of the receive module. If no sensor data is received for a certain amount of time (time threshold), the corresponding sensor is marked as impaired for the parameter adaption module.

## E. Context-Aware Sensor Degradation

Degradation of single sensors in case of certain environmental conditions. E.g., bright sunlight. The confidence ranges of each sensor shall be adapted.

For the context aware sensor degradation, the health state of each perception sensor has to be determined. This is done by utilizing data from the other perception sensors (vision camera) as well as special context sensors (e.g., light/temperature). A separate module is in charge of detecting the degradation using that input data and forwarding the degradation state to the Confidence- Range module. The confidence range module is then in charge of setting the confidence range for the corresponding sensor accordingly. Use cases can then utilize the confidence range as well as additional input in order to increase the robustness of their fusion modules.

## F. Resolution Reduction

Reduce resolution of the sensor in order to reduce the utilization of the memory cells. This is done after the safety monitoring system detected high memory utilization in order to reduce the wear of single memory cells.

In order to adapt the resolution of a sensor, the parameter-adaption module has to be aware of the memory utilization. Thus, a separate module has to determine the current measurement utilization and make it available to the parameter-adaption module. In case of a high memory utilization (thresholds, decision function), the parameter adaption module is then used to change the sensors resolution.

## G. Implementation

In order to provide the novel safety concepts, the existing platform had to be extended in hardware and software. This

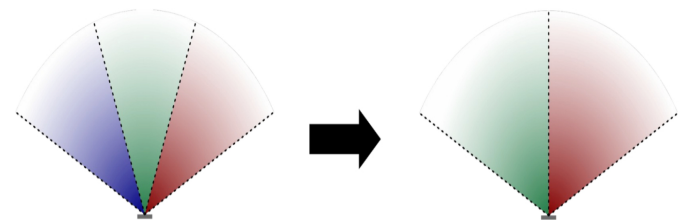

Fig. 4. Concept overview of the Field-of-View Adaption in Case of Sensor Failure.



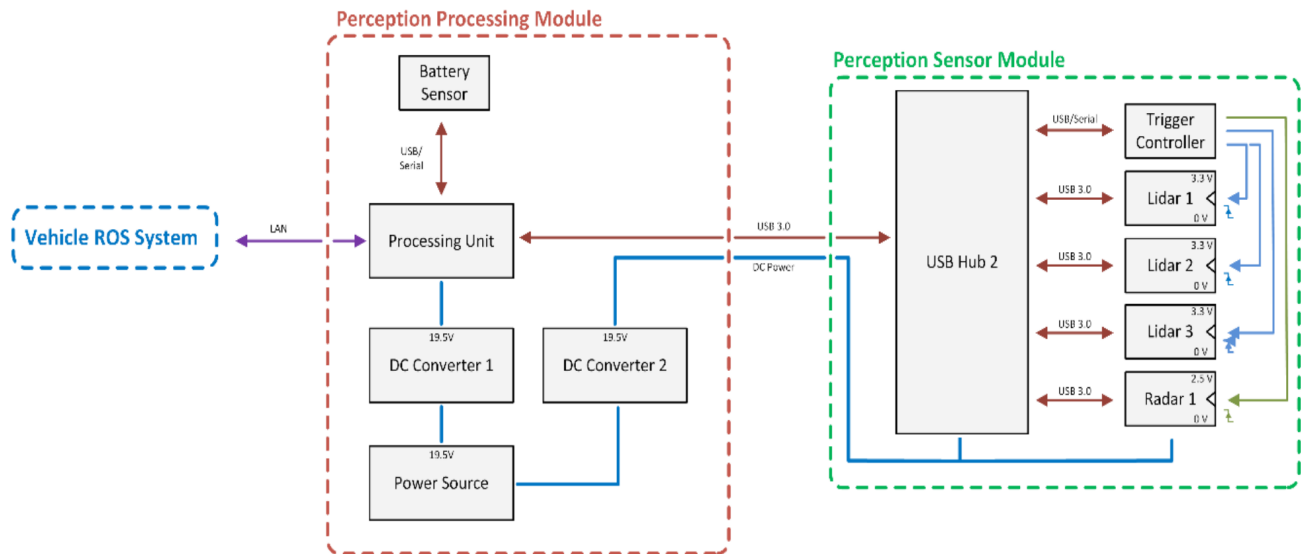

Fig. 5. Hardware Architecture of the used Prototyping Platform that has been used for the Use Cases.

section shows the hardware and software changes in more detail.

The existing platform was extended with a third ToF camera (3D flash lidar). Additionally, the whole setup was re-arranged and built in a more robust way. This enables the mounting of the platform on moving platforms. Figure 5 shows an overview of the final hardware setup. With that setup it is possible to perform the safety critical measurements. The hardware platform can be split into a Perception Processing Module and a Perception Sensing Module. While the processing module contains the heavy battery as well as the Intel NUC processing unit, the sensing module only contains the sensors and their supplementary hardware. Thus, the sensing module is less bulky and allows direct mounting on external platforms.

The software architecture is based on the Robot Operating System (ROS) framework. For this work, the Kinetic Kame distribution release was used. All processing modules are implemented as (C++ or python) ROS nodes, which subscribe to

input topics and publish output topics. The initial configuration of the ROS nodes is set via ROS parameters, defined in configuration files. Dynamic changes of node parameters can be performed via ROS services, where a request is sent to the node containing new parameter values. The node then answers with a response, indicating whether the parameter change was successful.

The architecture is split into several sub-systems: the base perception system and multiple use cases. The base perception system is in charge of the low-level data processing, sensor configuration, spatio-temporal alignment and pre-processing of the raw sensor data. The output of the base perception system are well-structured data streams of different abstraction levels. These data streams can then be used by the use-case subsystems in order to perform application specific processing.

An additional use case sub-system, called PRYSTINE, was added to the software architecture of the environmental perception platform on use-case level. The part of the architecture, subject to the developments of this report is highlighted with color, while the remaining part of the architecture is grayed out. The PRYSTINE subsystem is in charge of detecting the contextual state (sensor degradation), the sensor health (FoV adaption in case of failure), the memory utilization (resolution reduction) and the environmental context (FoV adaption for urban/highway). These outputs are then forwarded to the parameter-adaption module of the sensors or the confidence range adaption module. The parameter adaption module utilizes service requests to the Receive/Pre-Processing modules of the base-perception-system in order to adapt the sensor configuration during runtime. The confidence range adaption module on the other hand permanently outputs a confidence range stream assigned to the data streams of the perception sensors (via same timestamp).



Fig. 6. Research vehicle that has mounted the Sensors Fusion Platform in the front.

## IV. RESULTS

This section provides visualization of the acquired measurement data for the different use cases. The data was recorded using the platform, mounted on the research vehicle as seen in Figure 6.

### A. Context Dependent Field-of-View

Figure 7 shows the recorded measurement data for the first use case. As seen in the left image (regular operation), the range sensor is used in wide-angle mode, but with a low confidence range. This setting is desirable for example in urban scenarios when the vehicle is driving at low speed but many dynamic objects (pedestrians, street signs, parked vehicles). The right image shows the (long range operation) which is active after a FoV change. In that case the range of the sensor is increased, but the FoV is decreased. This setting is desirable in highway scenarios, when the vehicle is driving at high speed in a structured like a highway.

### B. Field-of-View Adaption in Case of Sensor Failure

The second use case shows the adaption of the sensor setups FoV in case of a sensor failure. For this use case, all three range sensors are utilized. Figure 8 shows the regular operation of the three sensors (point clouds visualized in different colors) and the corresponding RGB image of the vision camera. The walking pedestrian is clearly visible in the setup.

The middle point-cloud data shows the visualized range data in case of a sensor failure (mid sensor) and the corresponding RGB image. As seen in the figure, the pedestrian is now not visible in the pointcloud any more and cannot be detected. Thus, the FoV of the range sensors is adapted as seen in the third point-cloud data. As seen in the figure, the two remaining sensor extend their coverage area, but have to lower their resolution. The pedestrian is now visible again, but at reduced detail level.

### C. Context-Aware Sensor Degradation

The third use case is the degradation of range sensors. As seen in Figure 9, the confidence range of the sensor is marked with the green confidence area, while the non-confident area is marked red. The range data outside of the confidence range is not considered for the sensor fusion.

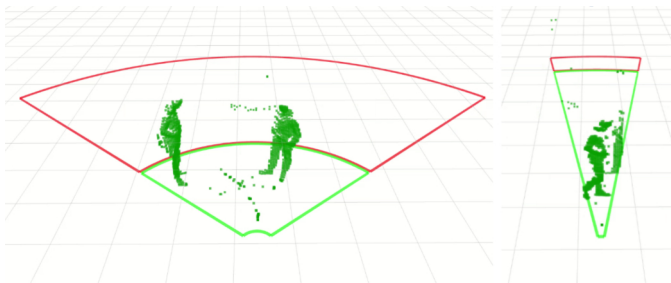

Fig. 7. Results of the Context Dependent Field-of-View use case.

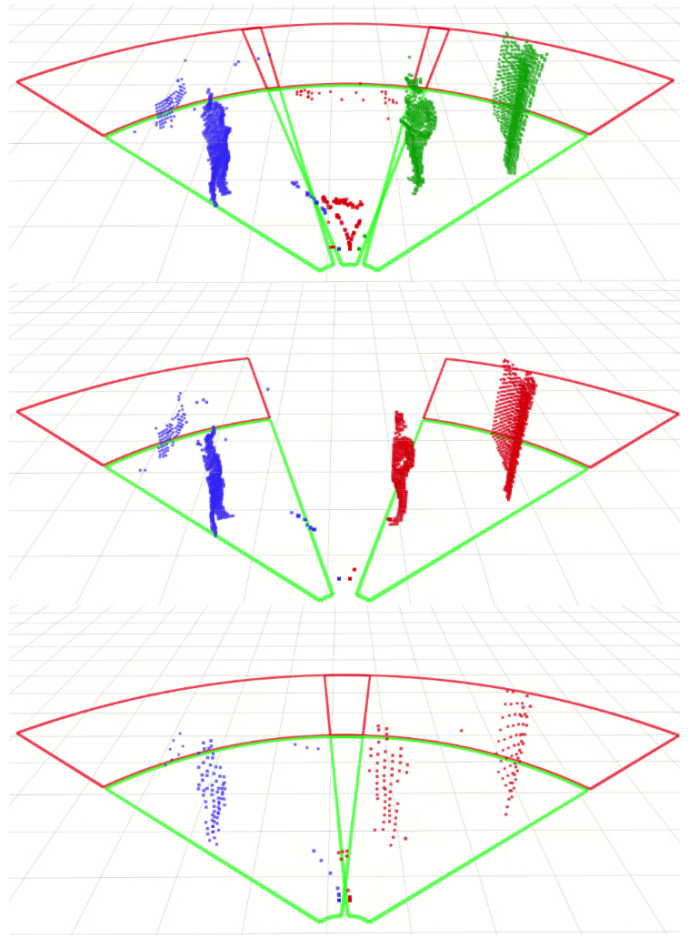

Fig. 8. Results of the Field-of-View Adaption in Case of Sensor Failure use case.

### D. Resolution Reduction

The fourth use case considers the memory utilization in order to decide on whether to reduce the resolution of a sensor in order to reduce the wear of the memory cells. For the demonstration of this use case, one range sensor was utilized. Figure 10 shows the point cloud output of the perception sensor for the full resolution. The lower point cloud output shows the sensor with reduced resolution. The number of points is significantly reduced in order to protect the memory; however the fine-grained detection abilities are also reduced, but is sufficient to detect the presence of obstacles.

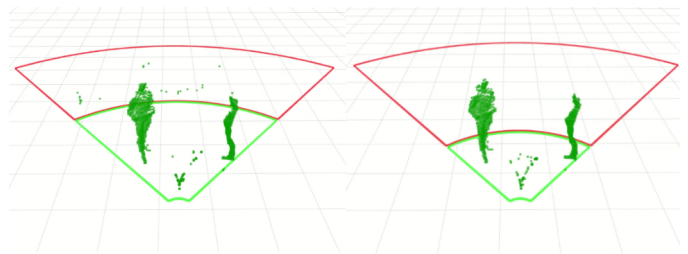

Fig. 9. Results of the Context-Aware Sensor Degradation use case.

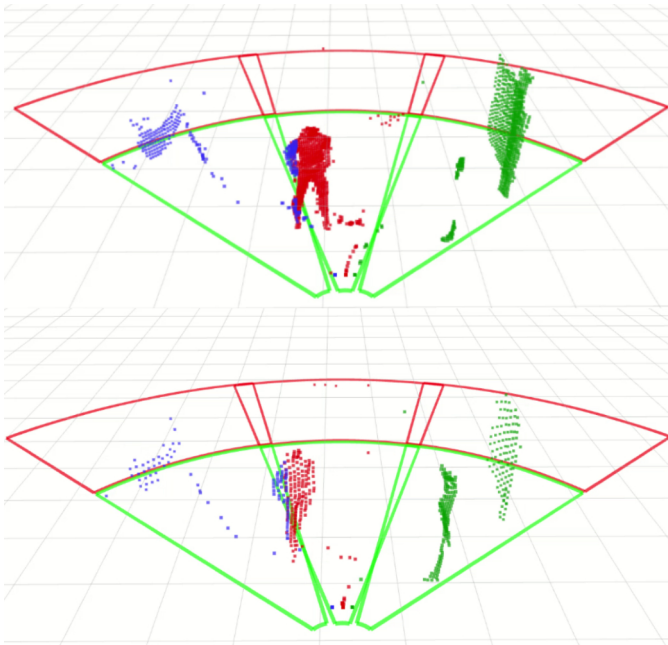

Fig. 10. Results of the Resolution Reduction use case.

## V. CONCLUSION

The platform was successfully utilized to evaluate multiple safety concepts in a real-world test-drive. The three ToF cameras of the platform were utilized to emulate solid-state LiDAR sensors, common sensors mounted on automated vehicles. Even though the ToF cameras have a significantly shorter range compared to solid-state LiDAR sensors, the structure of the provided data is very similar and thus, the findings based on the ToF cameras can be directly transferred to LiDAR sensors. The vulnerability of the ToF sensors to direct sunlight was utilized to demonstrate the sensor degradation in different ambient light conditions. Due to the limited range of the ToF sensor, the use cases were recorded in scenes with close objects. When transferring the results to a long-range LiDAR setup, the distance values can be upscaled to the range of the LiDAR sensor. The system provided good results in recognizing the context states and switching between the different modes. The adaption of the ToF sensors takes a few milliseconds but can be fully performed during runtime without the need to perform a sensor restart. The evaluation of the data obtained during the test drive showed the necessity and the potential of safety methods in order to provide robust perception data in any scenario.

## ACKNOWLEDGMENTS

The authors would like to thank all national funding authorities and the ECSEL Joint Undertaking, which funded the PRYSTINE project under the grant agreement number 783190.

PRYSTINE is funded by the Austrian Federal Ministry of Transport, Innovation and Technology (BMVIT) under the program ICT of the Future between May 2018 and April 2021 (grant number 865310). More information: <http://iktderzukunft.at/en/>.

## REFERENCES

- [1] N. Druml, G. Macher, M. Stolz, E. Armengaud, D. Watzenig, C. Steger, T. Herndl, A. Eckel, A. Ryabokon, A. Hoess, S. Kumar, G. Dimitrakopoulos, and H. Roedig, "Prystine - programmable systems for intelligence in automobiles," in *2018 21st Euromicro Conference on Digital System Design (DSD)*, Aug 2018, pp. 618–626.
- [2] M. Dikmen and C. Burns, "Trust in autonomous vehicles: The case of tesla autopilot and summon," in *2017 IEEE International Conference on Systems, Man, and Cybernetics (SMC)*, Oct 2017, pp. 1093–1098.
- [3] I. n. E. ISO, "ISO 26262 2nd Edition: Road vehicles-Functional safety," *International Standard ISO/FDIS*, vol. 26262, 2018.
- [4] S. Levin, "Tesla fatal crash: 'autopilot' mode sped up car before driver killed, report finds," Jun 2018. [Online]. Available: <https://www.theguardian.com/technology/2018/jun/07/tesla-fatal-crash-silicon-valley-autopilot-mode-report>
- [5] J. Steinbaeck, N. Druml, A. Tengg, C. Steger, and B. Hillbrand, "Time-of-flight cameras for parking assistance: A feasibility study," in *2018 12th International Conference on Advanced Semiconductor Devices and Microsystems (ASDAM)*, 2018, pp. 1–4.
- [6] J. Steinbaeck, A. Strasser, C. Steger, E. Brenner, G. Holweg, and N. Druml, "Context-aware sensor adaption of a radar and time-of-flight based perception platform," in *2020 IEEE Sensors Applications Symposium (SAS)*, 2020, pp. 1–6.
- [7] J. Steinbaeck, C. Steger, E. Brenner, G. Holweg, and N. Druml, "Occupancy grid fusion of low-level radar and time-of-flight sensor data," in *2019 22nd Euromicro Conference on Digital System Design (DSD)*, 2019, pp. 200–205.
- [8] J. Steinbaeck, C. Steger, G. Holweg, and N. Druml, "Design of a low-level radar and time-of-flight sensor fusion framework," in *2018 21st Euromicro Conference on Digital System Design (DSD)*, 2018, pp. 268–275.
- [9] R. Mariani, "An overview of autonomous vehicles safety," in *2018 IEEE International Reliability Physics Symposium (IRPS)*, March 2018, pp. 6A.1–1–6A.1–6.
- [10] O. Emmerich, H. Wang, G. Garcia, I. Pezzulla, A. Darlington, and B. Gao, "A systems engineering framework and application to an open automated driving platform," in *IECON 2020 The 46th Annual Conference of the IEEE Industrial Electronics Society*, 2020, pp. 2393–2398.
- [11] S. Kokogias, L. Svensson, G. Collares Pereira, R. Oliveira, X. Zhang, X. Song, and J. Mrtensson, "Development of platform-independent system for cooperative automated driving evaluated in gcdc 2016," *IEEE Transactions on Intelligent Transportation Systems*, vol. 19, no. 4, pp. 1277–1289, 2018.
- [12] C. Pilz, G. Steinbauer, M. Schratte, and D. Watzenig, "Development of a scenario simulation platform to support autonomous driving verification," in *2019 IEEE International Conference on Connected Vehicles and Expo (ICCVE)*. IEEE, 2019, pp. 1–7.
- [13] T. Bijlsma, M. Kwakkernaat, and M. Mnatsakanyan, "A real-time multi-sensor fusion platform for automated driving application development," in *2015 IEEE 13th International Conference on Industrial Informatics (INDIN)*. IEEE, 2015, pp. 1372–1377.